

We
build Emotions

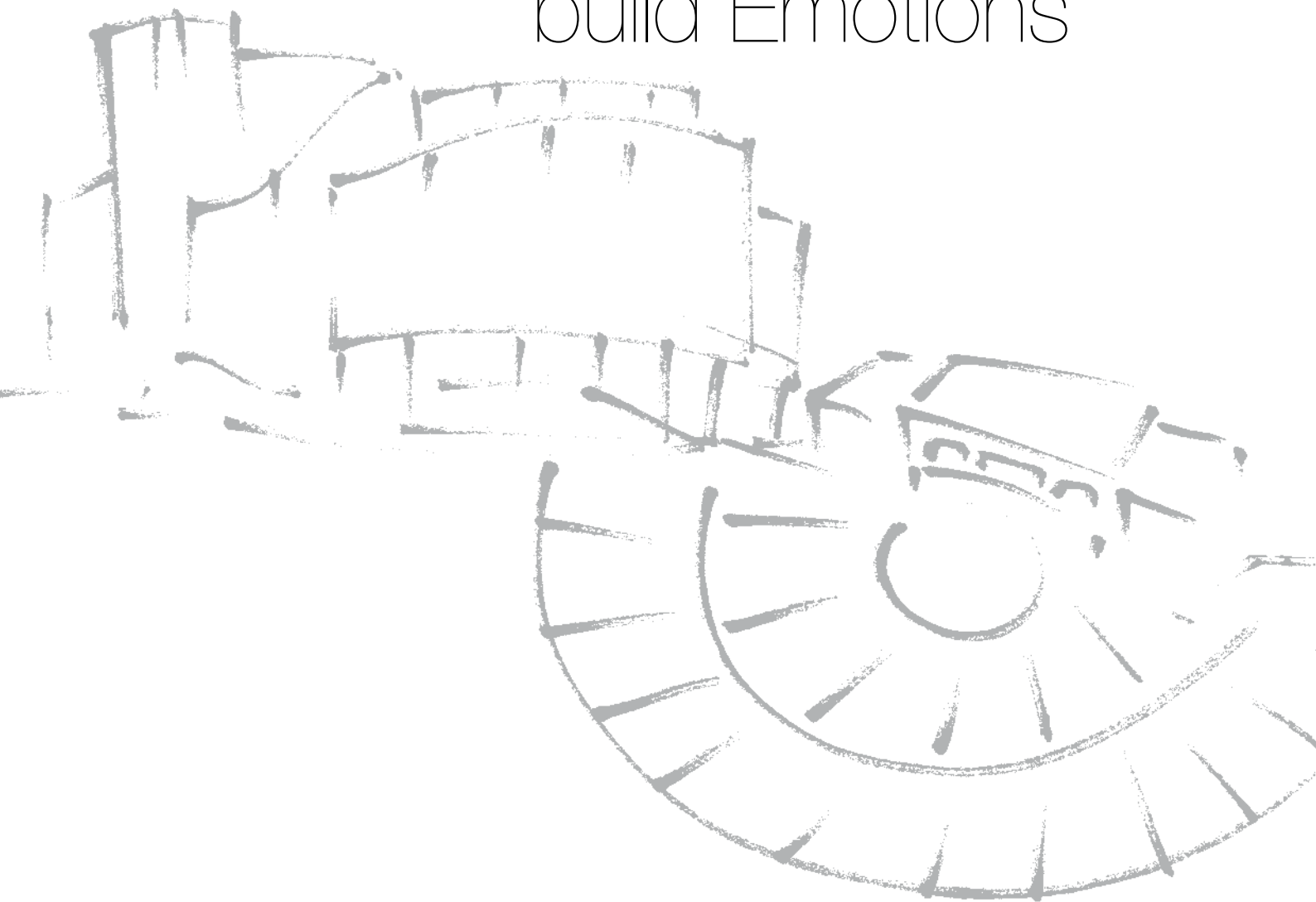

DECIMA
1948

Furnishings and technology
for theatre, music and performing arts

About us

Starting in 1948 Decima has acquired technical experience and new skills in the field of technology and furnishing for theatre, music and performing arts. The Company is highly qualified in manage Stage Machinery systems such as Fly systems, rigging, staging and motion control system. Decima sew several kinds of stage curtains in velour and fabric, with decorative trimming. The company also provides acoustical solutions for theatres, stage lighting systems and public address systems, included their control systems and other equipment.

The team of Decima includes various skilled designers (architects, theatre design, mechanical engineers, electronic engineers, light designers, electrical engineers), according to the different theatre needs and requirement, project managers, site managers and specialised site workers.

The interdisciplinary teamwork of the Decima responds to the different needs and typologies of performing art systems, including the technical approach depending on whether it is historical or contemporary theatre. Decima develop innovative stage systems also for existing theatres, updating fly system technologies, improving flexibility of the stage and the safety level of their motion control system.

Decima have a long experience to manage stage technologies into peculiar historical theatres, to permit also extend the stage into the audience, increasing the flexibility of the room. At the same time is extremely important to keep a philological approach for reproduce decorative parts such as the draperies.

Due at the diversity of types of the performing arts, Decima often develop different solutions for each projects.





Decima boasts several references of projects carried out mainly Italy, due to the large number of historical theatres in the area, and all over the world. Many of them are prestigious and the company continues to keep relationship, especially for maintenance of the stage technology and upgrading of the stage system.

Decima also encourage relationship with designers, technicians and consultants, such as stage designers, acousticians, light designers, scenographers and set designers, to improve the company skills.

1/2019 edition





Decima department fields

Fly System & Rigging

- Stage Grids 
 - Stage winches
- 
- 
- 
- Chain hoist systems
 - Counterweight rigging system
 - Lighting battens
 - Lighting bridge system
 - Fire safety curtains
 - Motion Control system



Staging

- Stage and orchestra platforms
- 
- Modular adjustable platforms 
 - Modular telescopic platforms 
 - modular outdoor & indoor stage platforms 
 - Stage wagons for scenery
 - Revolving platforms
 - Platform for audience (FOH) areas

Stage curtains and draperies

- Front curtains:
 - Traveler curtains
 - Tableau curtains
 - Austrian curtains
- Stage Curtain track system
- Proscenium drapes
- Black box system
- Backdrop and cycloramas
- Several decorations and passementeries
- Reproduction of original embroidered decorations
- Curtain for audience (FOH) areas

AV integrated systems

- Lighting systems and controls for stage and show
- Architectural lighting systems
- Video and movie projections
- CCTV systems
- Public address systems
- Simultaneous translation
- Electroacoustic design system
- Projection screens

Acoustical solutions

- Acoustic orchestra shells
 - Gran Teatro
 - Ceresium
 - Haydn
- Acoustical cladding and ceiling solutions for theatres
- Variable reverberation system
- Acoustic projects

Seats

- Fold -away seat system 
- Seats for theatre lodges
- Armchairs for theatres
- orchestra and musician chairs



DECIMA
1948



Hystorical Theatres

Since
1948





Teatro Galli

Rimini

Fly system

- Timber and steel stage grid
- Multiple hoist rigging system LIFTEC
- Single point hoist system LIFTEC live
- Light battens LIFSTART
- Motion Control system CURIO

Staging and acoustic cladding

- Orchestra pit platform
- Freight and scenery stage lift
- Timber stage/orchestra flooring
- Removable timber stage floor panels
- Orchestra pit acoustic plywood cladding and movable panels

Curtains and orchestra shell

- Front traveler decorated curtain
- Center stage traveler curtain
- Curtains rigging system
- Proscenium velour teaser and draperies

Stage lighting

- Dimming system
- Light control boards

AV integrated system

- Public address
- TVCC





Teatro Carignano

Torino

House Traveler Curtain in velvet and 3 different proscenium drapery Borders, with track and fly system.
 Draperies for the whole audience areas
 Decorated damask fabric acoustic cladding of the lodges.
 Stage light control system with 248 digital dimmers mod. ETC "Sensor" and lighting control board

Orchestra pit platform
 Movable stage
 Stage grid
 I-beams system
 Chain hoists





Gran Teatro La Fenice

Venezia

Fly system

- timber and steel stage grid
- electrical hoist rigging system
- Manual hemp rigging system
- Manual counterweight rigging system
- Fire safety curtain
- light battens
- proscenium lighting bridge
- projection and transation screen
- Motion Control system



Staging

- Orchestra pit platform
- Timber stage/orchestra flooring

Curains and orchestra shell

- Main tableau decorated curtain,with 1100 gold leaf leather flowers
- Curtain rigging system
- Proscenium velour teaser and draperies
- Black box
- multilayer acoustic curtain
- orchestra pit acoustic plywood cladding and movable panels
- Orchestra shell

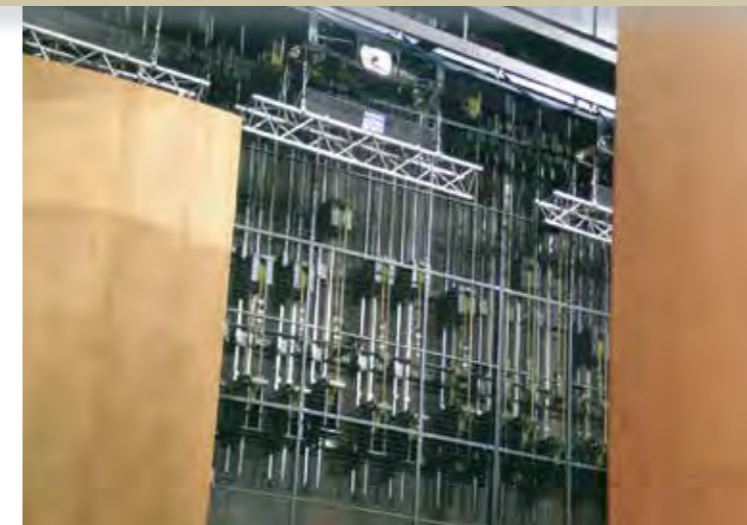



Teatro Massimo Bellini Catania

- Front traveler curtain and proscenium teaser, made in velvet with decorations like the original
- curtains in audience areas.
- curtain rigging system
- draperies in lodges and royal lodge, decorated as the original
- Chairs for lodges and royal lodge
- electrical hoist rigging system
- light battens
- Hydraulic orchestra pit platform
- refurbishment of the painted coat of arms





Teatro Sociale

Trento

Fly system

- timber and steel stage grid
- electrical hoist rigging system
- Manual hemp rigging system
- Fire safety curtain
- light battens
- proscenium lighting bridge
- Motion Control system



Staging

- 30 stage platforms
- 2 Orchestra pit platform
- Timber stage/orchestra flooring

Curtains and orchestra equipment

- Main traveler curtain and track rigging system
- Proscenium velour teaser and draperies
- orchestra pit acoustic plywood cladding
- Orchestra seats and music stands





Teatro Massimo di Ortigia Siracusa

Fly system and curtains

- Steel stage grid
- Front traveler curtain and track rigging system
- Velour decorative drapery borders
- Stage black box
- Manual hemp rigging system

- Audience area velvet curtains and draperies
- Acoustic decorative fabric damask for theatre lodges and balconies cladding
- Draperies of the lodges and balconies
- Audience armchairs
- Lodges and balconies chairs and stools



Teatro Sociale Arrigoni San Vito al Tagliamento

Audience Curtains and drapes

- Audience area velvet curtains and draperies
- Acoustic decorative fabric damask for theatre lodges and balconies cladding
- Draperies of the lodges and balconies
- Audience armchairs
- Lodges and balconies chairs and stools

Fly system and stage curtains

- Front traveler curtain and track rigging system
- Decorative trimming embroidery on curtain
- Velour decorative drapery borders
- Stage black box
- Manual hemp rigging system

Staging

- Timber stage flooring and scenery traps





Teatro Verdi Fiorenzuola d'Arda

- Fly system, automated and manual hemp
- Orchestra pit platform and stage/ orchestra timber flooring
- Stage curtains and black box
- Acoustic decorative fabric damask for theatre
- Restoration of the original lodges chairs and stools



Teatro Regio Parma

Steel rigging frame beams for the track of the new rolling lifting hoists. The steel frame is completely integrated into the XIX century existing wooden beam system of the stage roof, without affecting its characteristics and appearance.





Contemporary Theatres

Since
1948

DECIMA
1948





Teatro Radar

Monopoli

Fly system

- Timber and steel stage grid
- Multiple winch rigging system **LIFTSTART**
- Single point chain hoist system
- Stage light battens rigging system
- FOH light battens rigging system
- Manual hemp rigging system
- Pin-rails for manual hemp
- Motion Control system **CURIO**

Staging

- Orchestra pit platform
- Freight and scenery stage lift
- Fold-away integrated seat system **FLEXSEAT**
- Fold-away seat system for handicapped **FLEXSEAT**

Curtains and orchestra shell

- Front traveler curtain
- Curtains rigging system
- Proscenium drapery borders
- Black box

Stage lighting

- Dimming system
- Light control boards
- Stage lighting

AV integrated system

- Public address
- Video system and roll-up screen





LAC Lugano Cultural Centre Lugano

Fly system

- Automated winch rigging system
- Fire safety curtain
- Light battens
- Proscenium lighting bridge
- Motion Control system 

Staging and flooring

- 3 Orchestra pit platforms with removable pit rail
- Freight and scenery stage lift
- Double level wagons for armchairs
- Oregon pine timber stage/orchestra flooring
- Scenery trap removable flooring panels
- Wengè timber audience flooring

Curtains and orchestra shell

- Front tableau curtain, with
- Curtain rigging systems for german, traveler and tableau open close
- Stage curtains
- Orchestra shell Ceresium





Auditorium Intesa S. Paolo: Torino

Auditorium located inside the bank Headquarters, designed by Renzo Piano Architect

Staging and seating

- Audience Spiralift® platforms system
- Fold-away seat system – Automatic seats retractable system in the underfloor
- Audience armchairs

Variable acoustic panels and Lighting system

- Automated rotating acoustic panels: sound reflecting and sound absorbing
- Light batten rigging system
- Roll-up projection screen





Teatro Eliseo Roma

Photo by: Stefano Bonagura

Fly system and curtains

- Stage steel grid
- Automated winch rigging system **LIFESTART**
- Chain hoist rigging system **EASYGRID**
- Manual hemp rigging system
- Light battens
- Motion Control system **CURIO**
- Curtain rigging systems for, traveler and tableau open close
- Front curtain
- Stage curtains
- black box

Lighting and public address

- Stage lighting control system with ETC
- ION control desk and Sensor dimming
- CODA Tiray sound system



Teatro Piccolo Eliseo Roma

- CODA Tiray sound system

Fly system and curtains

- Stage german grid system **LIFESTUDIO**
- Automated winch rigging system **CURIO**
- Motion Control system
- Curtain traveler rigging systems
- Front traveler curtain
- Stage curtains
- Black box

Lighting and public address

- Stage lighting control system with ETC
- control desk and dimming
- CODA Tiray sound system





Teatro Splendor

Aosta

- Timber and steel stage grid
- Automated winch rigging system LIFTEC LT75
- Light battens, dimming and control lighting system
- Manual hemp rigging system
- Motion Control system
- Stage curtains and track rigging system
- Orchestra pit platform
- Scenery automated trap-door
- Stage manual modular platform FLEXDECK
- Timber stage/orchestra/audience flooring
- Acoustic orchestra shell - Ceresium
- Acoustic automated adjustable proscenium panels
- Acoustic orchestra pit, Main hall and lecture hall cladding
- Theatre armchairs and removable seats for lecture hall
- Public address system and equipment



Teatro Coliseo - Palazzo Italia

Buenos Aires

- Automated winch rigging system LIFTEC LT-60-5V
- Chain hoist rigging system
- Upgrade of the fire safety curtain winch rigging system
- Motion Control system CURIO

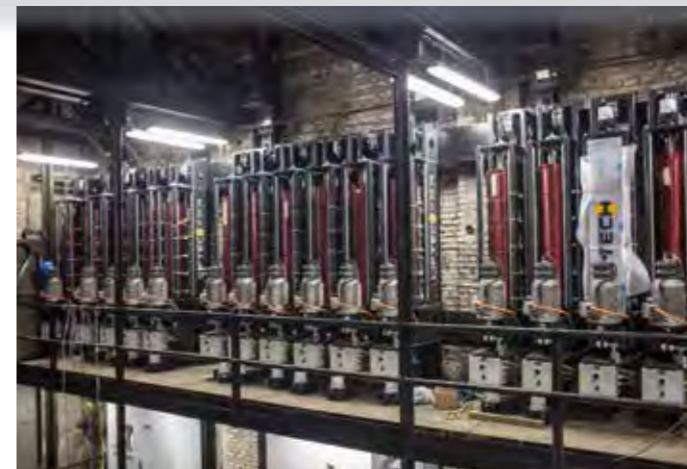



Teatro Elfo Puccini Milano

- Steel stage grid - Easygrid
- Automated winch rigging system **LIFTSTART**
- Front curtain with traveler track rigging system
- Modular manual stage platforms **FLEXDECK**



Piccolo Teatro Milano

- Front traveler curtain and track rigging system
- Motion Control system **CURIO**
- Audience velvet drapes
- Foyer furnishings

Teatro Sociale Alba

- Stage steel grid
- Stage winch rigging system
- 2 Front traveler curtains and track rigging system
- 2 fire safety curtains
- Light battens
- Double front stage system
- Audience armchairs for both historical and contemporary theatres

A 19th century theatre and a contemporary one, with central stage





Teatro delle Muse

Ancona

Photo by: Stefano Bonagura

Fly system

- Timber and steel stage grid
- Automated winch rigging system
- Decorative Fire safety curtain
- Light battens and stage lighting control system
- Proscenium variable acoustic ceiling
- Motion Control system

Staging and stage flooring

- Automated stage platforms
- Orchestra pit platform
- Timber stage/orchestra flooring

Curtains and orchestra shell

- Main traveler curtain with rigging system
- Proscenium velour teaser and draperies
- Black box
- Acoustic Orchestra shell





Teatro Verdi Pordenone

2 halls: main and small theatre

Fly system

- Timber and steel stage grid
- Rolling automated winch rigging system
- Manual hemp rigging system
- Light battens and stage lighting control system
- Motion Control system

Staging and stage flooring

- Automated stage platforms
- Orchestra pit platforms
- Timber stage/orchestra flooring

Curtains and equipment

- Main traveler curtain with rigging system
- Proscenium velour teaser and draperies
- Black box
- Public address system
- Double movie and Dolby system with screens
- Small theatre stage machinery and curtains
- Orchestra stands and chairs

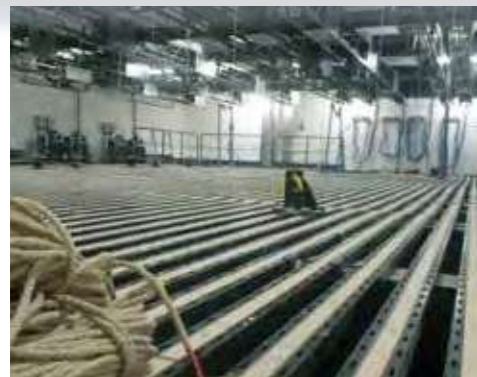

Teatro Corte Coriano

Fly system

- Full timber stage and audience acoustic grid
- Automated winch rigging system
- Manual hemp rigging system
- Light battens integrated with acoustic ceiling panels
- Motion Control system

Staging and stage flooring

- Modular stage adjustable manual platforms **FLEXSTAGE**
- Freight and scenery stage lift
- Timber stage flooring
- Curtains and equipment
- Stage curtains with rigging system
- Proscenium velour teaser and draperies
- Black box

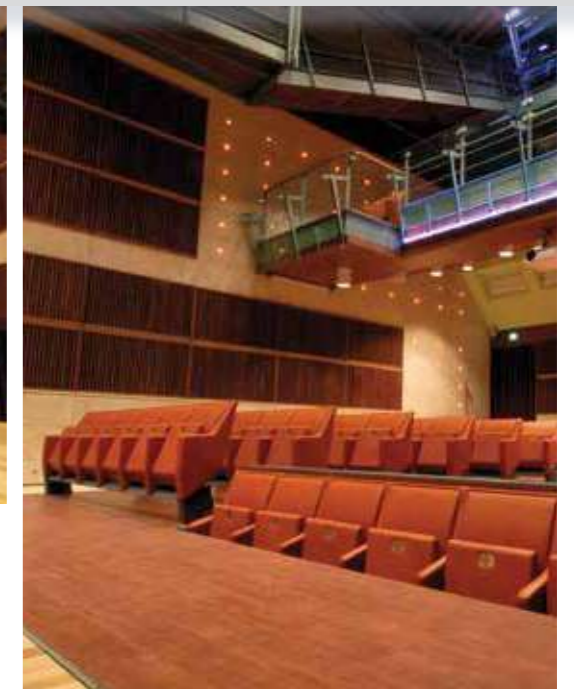



Auditorium Arzachena Costa Smeralda

Fly system

- Stage steel grid **EASYGRID**
- Automated winch rigging system **LIFTEC**
- Manual hemp rigging system
- Light battens and stage lighting control system

Staging and stage flooring

- Modular stage adjustable manual platforms **FLEXSTAGE**
- Timber stage flooring

Curtains, acoustic and equipment

- Stage curtains with rigging system
- Proscenium velour teaser and draperies
- Black box
- Acoustic wooden wall cladding and ceiling
- Audience area curtains
- New entrance/foyer/duty areas furniture
- Public address system

Auditorium San Giacomo Laives

Fly system and stage flooring

- Automated winch rigging system **LIFTSTART**
- Manual hemp rigging system
- Light battens, towers and stage lighting control system
- Timber stage flooring

Curtains

- Stage curtains with rigging system
- Proscenium velour teaser and draperies
- Black box

Acoustic

- Acoustic wooden wall cladding and ceiling





Teatro Remondini

Bassano
del Grappa

Fly system and stage flooring

- Steel "German" grid structure
- Automated winch rigging system
- Manual hemp rigging system
- Light battens, towers and stage lighting control system
- Timber stage flooring

Curtains

- Stage curtains with rigging system
- Audience curtains
- Proscenium velour teaser and draperies
- Black box

Acoustic and furnitures

- Acoustic wooden, gypsum and leather wall cladding and ceiling
- Public address system
- Armchairs - OPERA
- New entrance/foyer/duty areas furniture



Teatro Diego Fabbri

Forlì

- Fly tower grid
- Full automated and manual fly system
- stage and orchestra platforms and timber flooring
- Stage and audience curtains

Teatro Politeama

Catanzaro

- Fly tower grid
- Full automated and manual fly system
- Stage and orchestra platforms and timber flooring
- Motion Control system
- Stage curtains and black box
- Stage lighting battens and light control system





Teatro Nuovo Giovanni da Udine

Udine

- Stage velvet tableau curtain maintenance
- Black box
- Upgrading of the Acoustic shell
Granteatro
- Audio system – Coda Tiray



Teatro Politeama Marostica

- Automated winch rigging system LIFTEC
- Motion Control system
- Manual hemp rigging system

Binario 7 Sala Picasso

Monza

- Stage curtains and black box
- Stage light batten and lighting control system
- Video system
- Audio system





State Auditorium

Astana Kazakhstan

- 12 Stage automated platforms
- Spiralift system
- Orchestra pit automated platform
- Spiralift system
- Motion Control system



Lyric Theatre

Assisi

- Fly system and staging**
- Stage steel grid
 - Automated winch rigging system
 - Manual hemp rigging system
 - Light battens and stage lighting control system
 - Timber stage and audience flooring



- Curains, acoustic and equipment**
- Stage curtains with rigging system
 - Black box
 - Acoustic wooden wall cladding and ceiling
 - Audience area curtains
 - New entrance/foyer/duty areas furniture
 - Public address system
 - Movie and Dolby system with roll-up screen

Teatro del casinò

Sanremo

- Front stage traveler curtain with rigging system
- Theatre armchairs - Opera



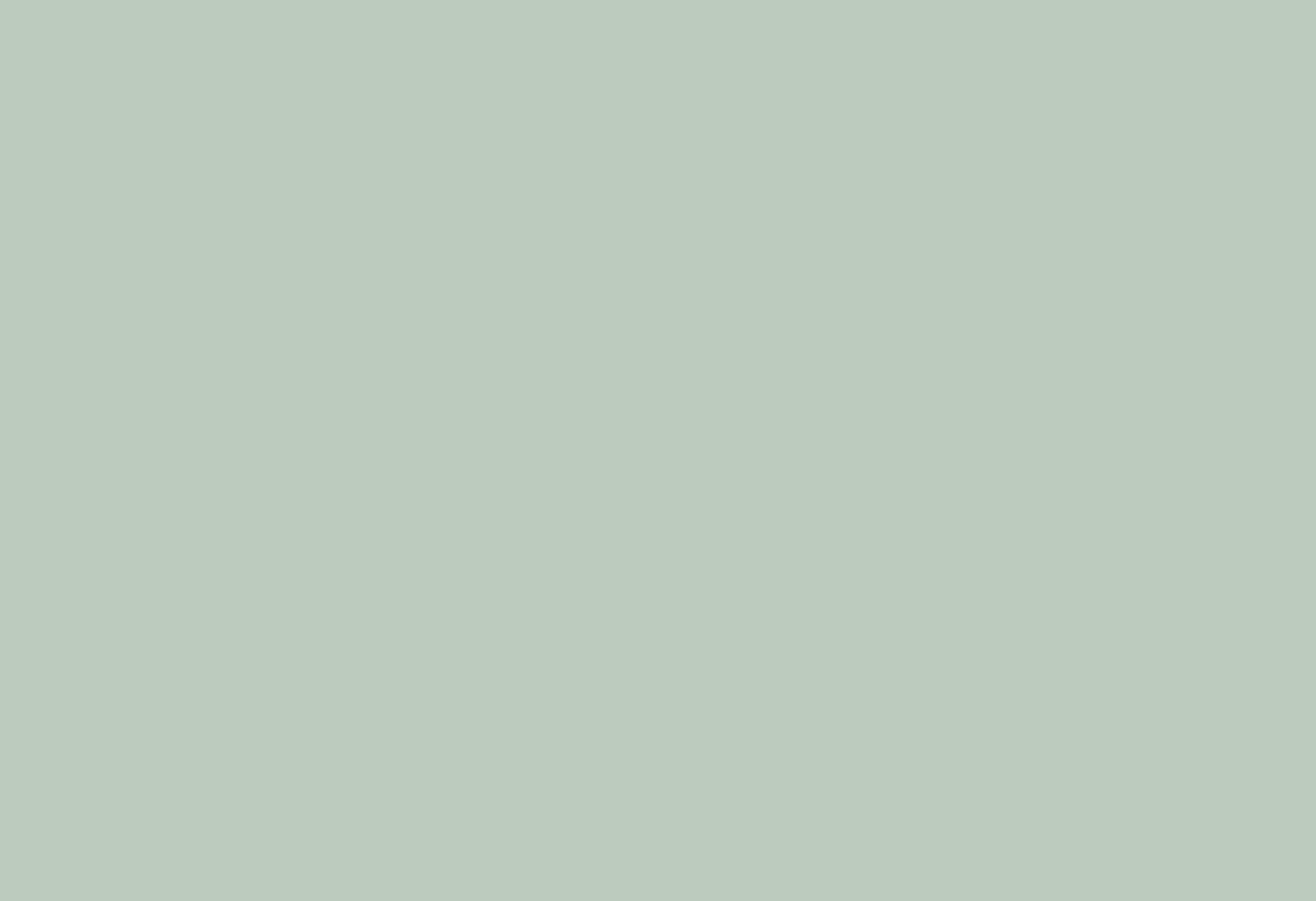

Congress Centre and
Lecture Halls

Since
1948

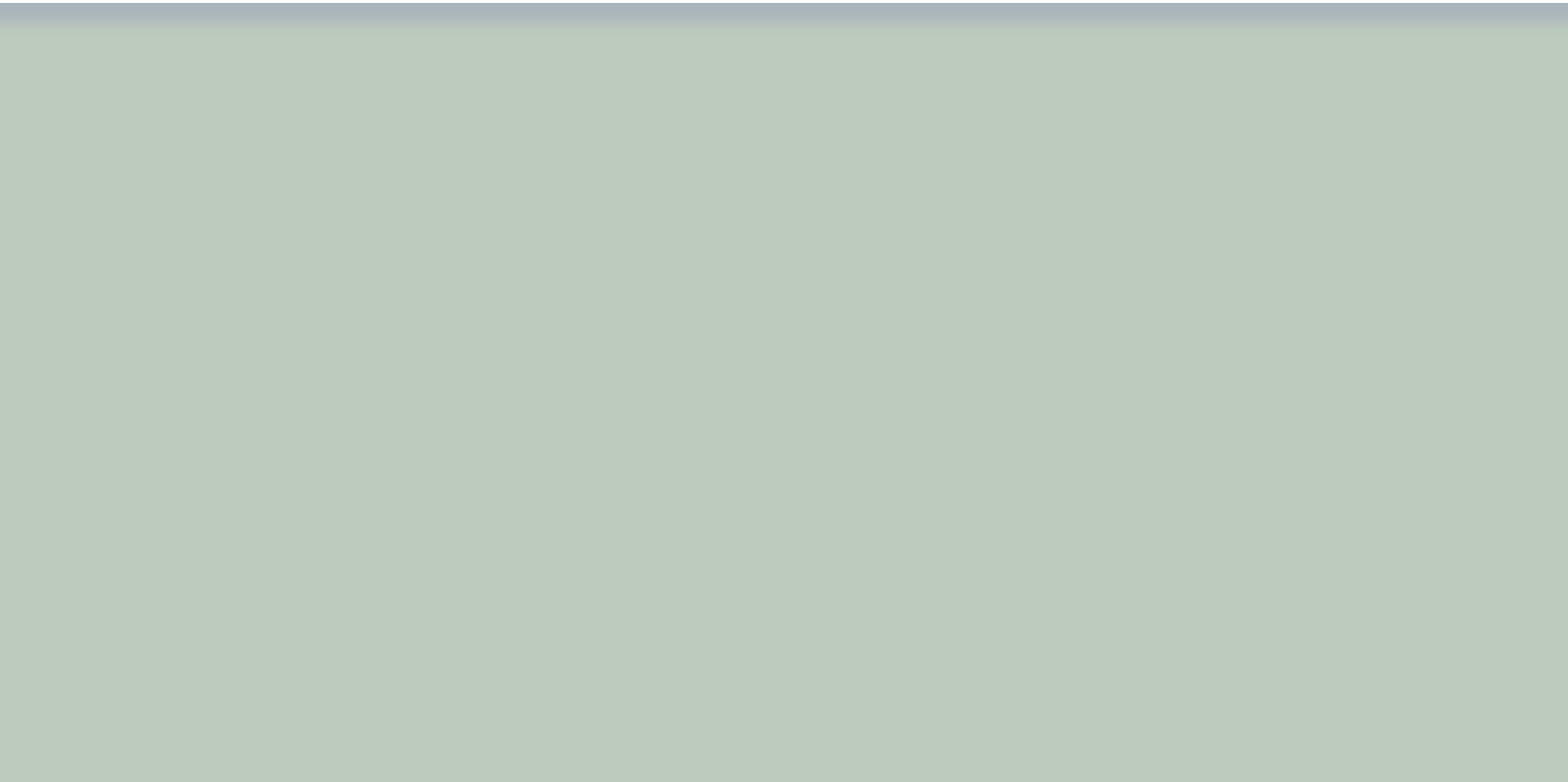



Palacongressi di Rimini

Rimini

Stage lighting system of the Conference Halls and Meeting Rooms:
 Stage lighting control System in several halls, with signal distribution on Ethernet ETC Net3 basis, connected to a general direction of supervision and safety, with advanced diagnostics systems.



According to their different dimensions, the halls are provided with stage lighting control desk, from the ETC wide range (ION, SmartFade, ML), with a mixed distribution of the Ethernet/DMX512 signals to allow the controls of any type of lighting fixtures.

- Lighting fixtures:**
- 150 fresnel fixtures, 650/1000/2000 W
 - 32 moving light Revolution
 - 20 PC 2500 W projectors
 - 56 profile zoom spot 25°/50° - 750 W
 - 10 low voltage profile spots, 1200 W

- Staging**
 50 system of Modular adjustable Platforms
- Rigging**
 Motorised Fly System for Lighting Chain hoists





Bocconi University

Aula Magna Milano

Fotografia digitale di Architettura © 2008
archivio Federico Brunetti

- Main hall of the prestigious University "Luigi Bocconi" in Milan:**
- Special acoustical wall cladding, in "Pietra Serena" stone slabs with Honeycomb underlayer, panel system.
 - Flooring in "white Lasa" marble slabs on floating support system
 - Stage flooring
 - Acoustical ceiling fly system

- Motorised stage hoists
- Audience insulating velvet Curtains
- Stage lighting
- Wood acoustical orchestra shell
- Motorised roller blind screens





Dasman bilingual School Main Auditorium

Kuwait City
TRI ALPHA CO.W.L.L)

- Timber Stage flooring
- Rigging:
Manual and electrical Fly system
metal grid
Motorised studio hoist
LIFSTUDIOLST-35/8
- Main velvet Traveler Curtain and fabric
Black Box
- Podium and lecturer tables
- ETC lighting fixtures.
- Audio Visual, Conference and public
address System



Pushcha Congress Hotel

Kiev

- Design, supply and installation for 3 halls**
- Stage Curtains & rigging system
- Audience fabric curtains
- Stage and audience lighting system
and control
- Acoustic cladding and ceiling
- Audio & video system
- Simultaneous translation system
- Movie projection system

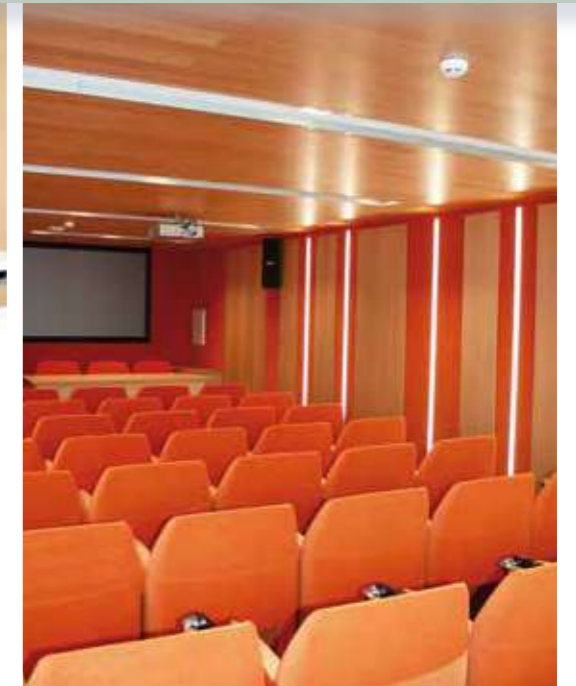



Auditorium of the Ferrero research centre

Alba

- Acoustic wood panel cladding system
- Movable sound insulating walls
- Acoustic gypsum sound absorbing ceiling
- Stage light batten system and control
- Architectural variable lighting system and control
- Black out automated window curtain system
- Modular manual adjustable platforms - flexstage
- Speaker cabled podium and conference table system
- Video system and roller blind screens
- Conference-system and public address system
- Tv recording and video conference system
- Various lecture hall special tables



Pietro Ferrero meeting room

Alba

- Glass & wooden cabled modular conference tables
- Wood furnishing with integrated roll-up automated screen
- Meeting and conference system

Lecture Hall Scarpa factory

Asolo

- Wooden cabled modular conference table system
- Speaker cabled podium and conference table system
- Black out automated window curtain system
- Truss equipped ceiling system
- Architectural lighting system
- Video system and roll-up screen
- Conference system and public address system





Centro Culturale Altinate-San Gaetano Padova

- Acoustic wood panel cladding system
- Acoustic gypsum sound absorbing ceiling
- Stage steel grid
- Architectural variable lighting system and control
- Audience armchairs - Clio
- Stage wood flooring
- Audience acoustic velvet acoustic cladding



Lecture hall Ascom Oderzo

- Acoustic wood panel cladding system
- Speaker cabled podium and conference table system

Conference Hall Ospedale di Feltre Feltre



- Rolling velvet traveler curtain and rigging system
- Fabric sound absorbing wall panel system
- Stage lighting battens and light control system



- Modular manual adjustable stage platform system
- Speaker cabled podiums and conference table system
- Multimedia integrated system equipment



Cineteca Pasinetti

Venezia

- Velvet sound absorbing wall cladding
- Velvet screen frame
- Audience armchairs – Opera

Cinemino

Milano

- Acoustic sound absorbing wall cladding (micro-perforated laminated panel system)
- Sonica Intone
- Screen fabric frame



Museum of Geology and Paleontology

Padova

- “Sala delle Palme” new exhibition system**
- Safety transparent tempered-glass sliding door system
 - Stand steel structure system
 - Black out curtain system
 - Lift interior decorative glass cladding

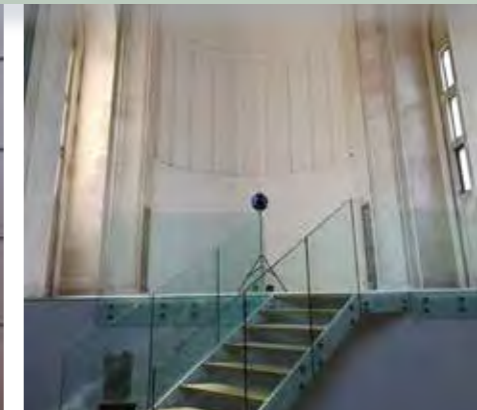

Museo della Certosa di Pavia

Pavia

- New reception area**
- Heating panel system
 - Desk area system design
 - Double glazing and metal plate panels

Tempio Votivo

Lido - Venezia

- Touch screen table system
- Audio system – Coda Audio Coray 4I- (on behalf of 3P)

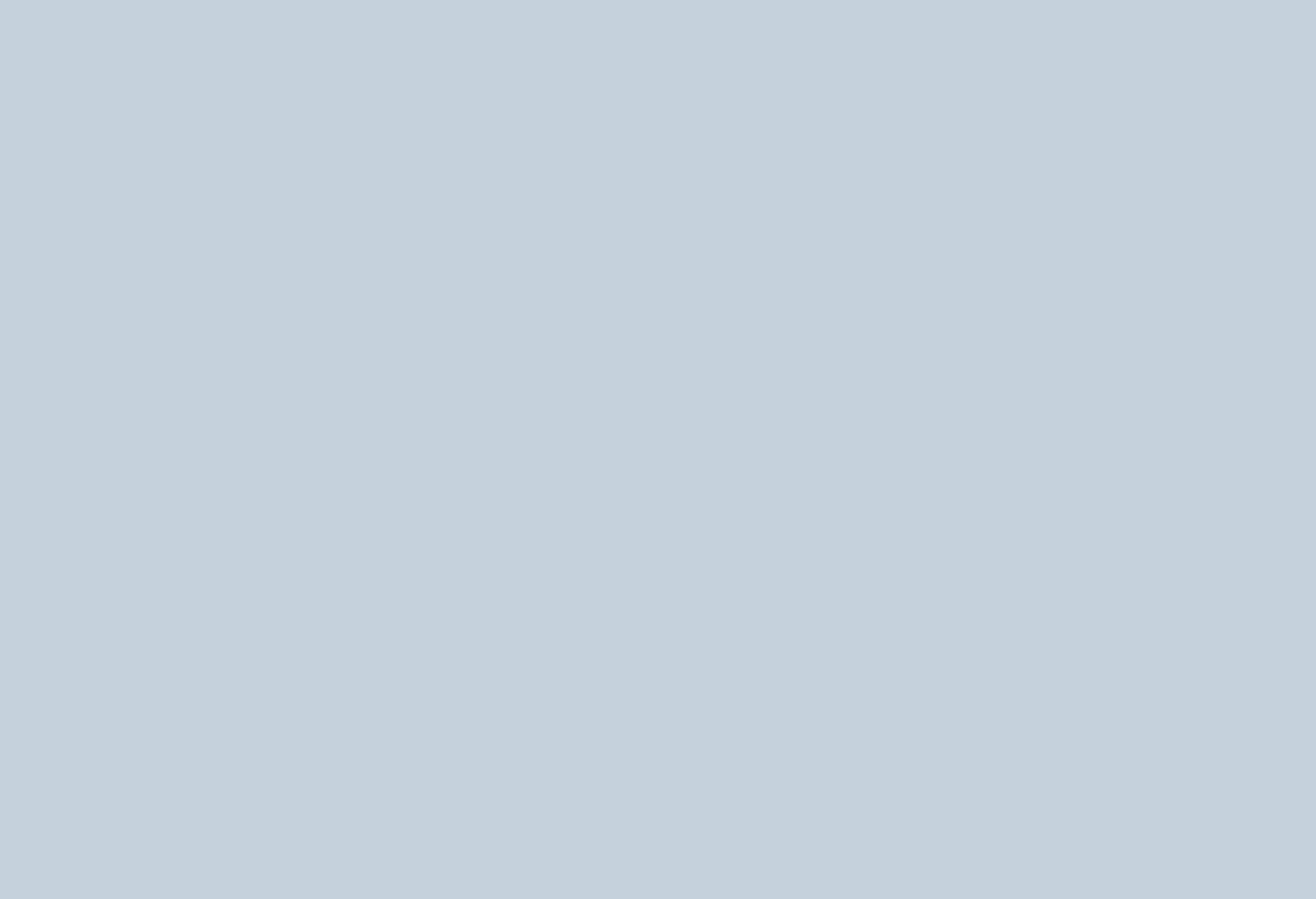

TV Studios

Since
1948

DECIMA
1948

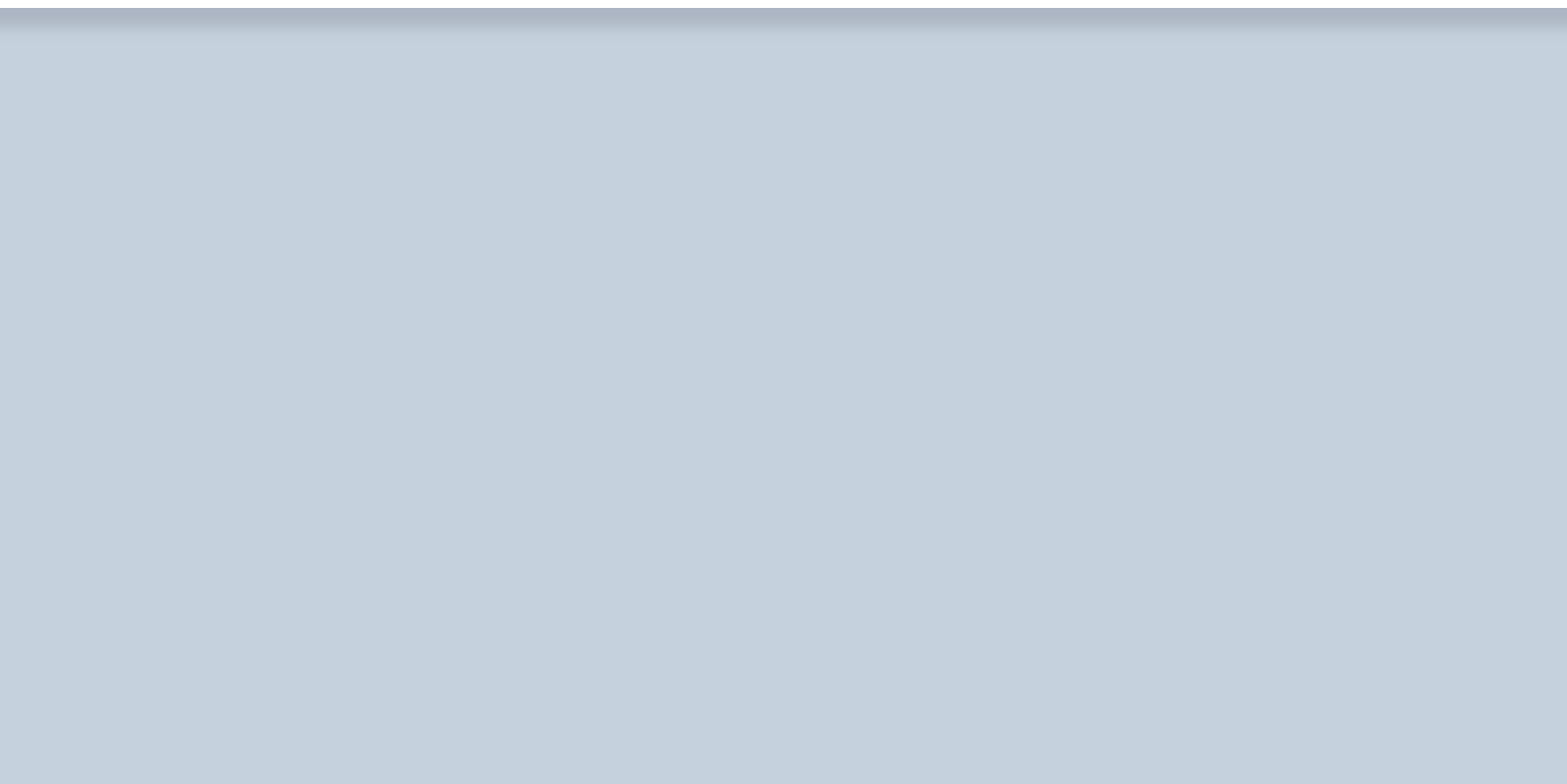



Next TV Broadcasting

Studio 2 and 3

Taipei Taiwan

- Stage rigging system with variable speed and control including:
- 123 pcs **Liftstart LS35** winches
- 2 pcs **MC3** motor controllers
- 2 pcs **MC50** portable motor controllers

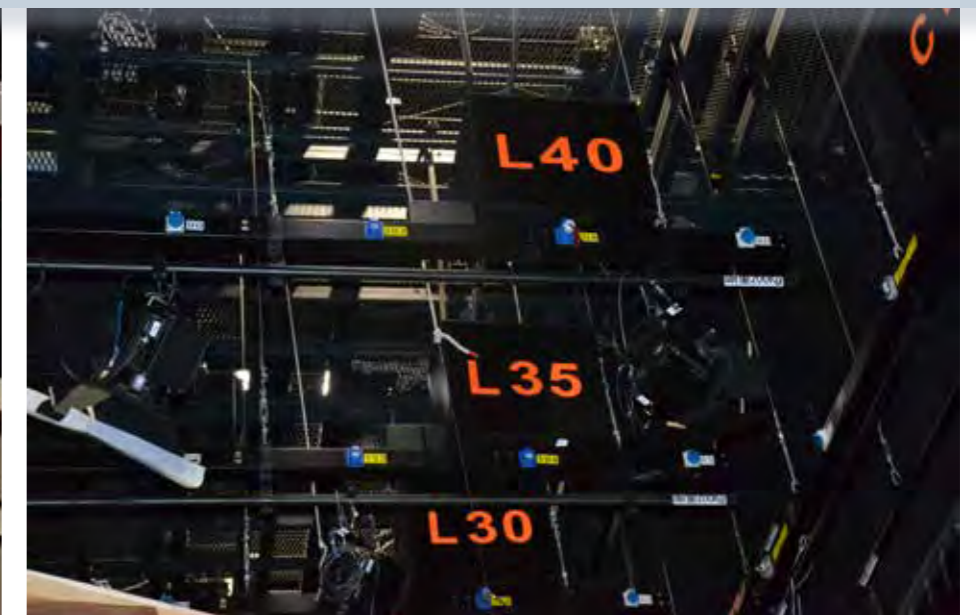



FTV Formosa Television

Taipei Taiwan

- 671 pcs Liftstudio JR TV hoist different type for 12 studio
 - Curio Motion Control, and MC3 + MC50 control board
 Supply from Anlitor Corporation Taiwan

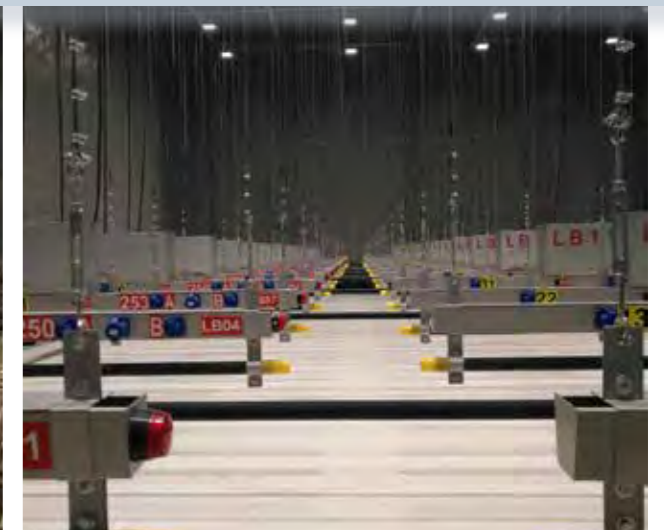
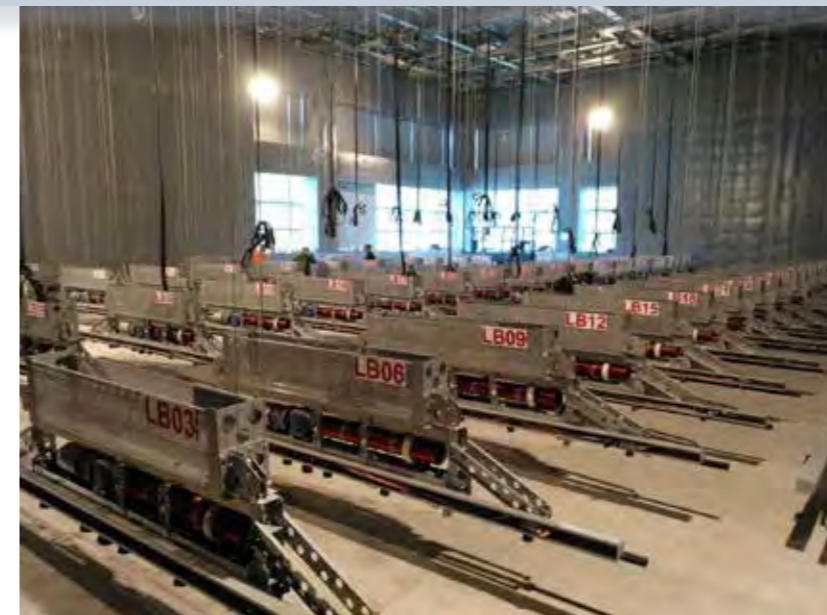



Live Show & Arenas

Since
1948

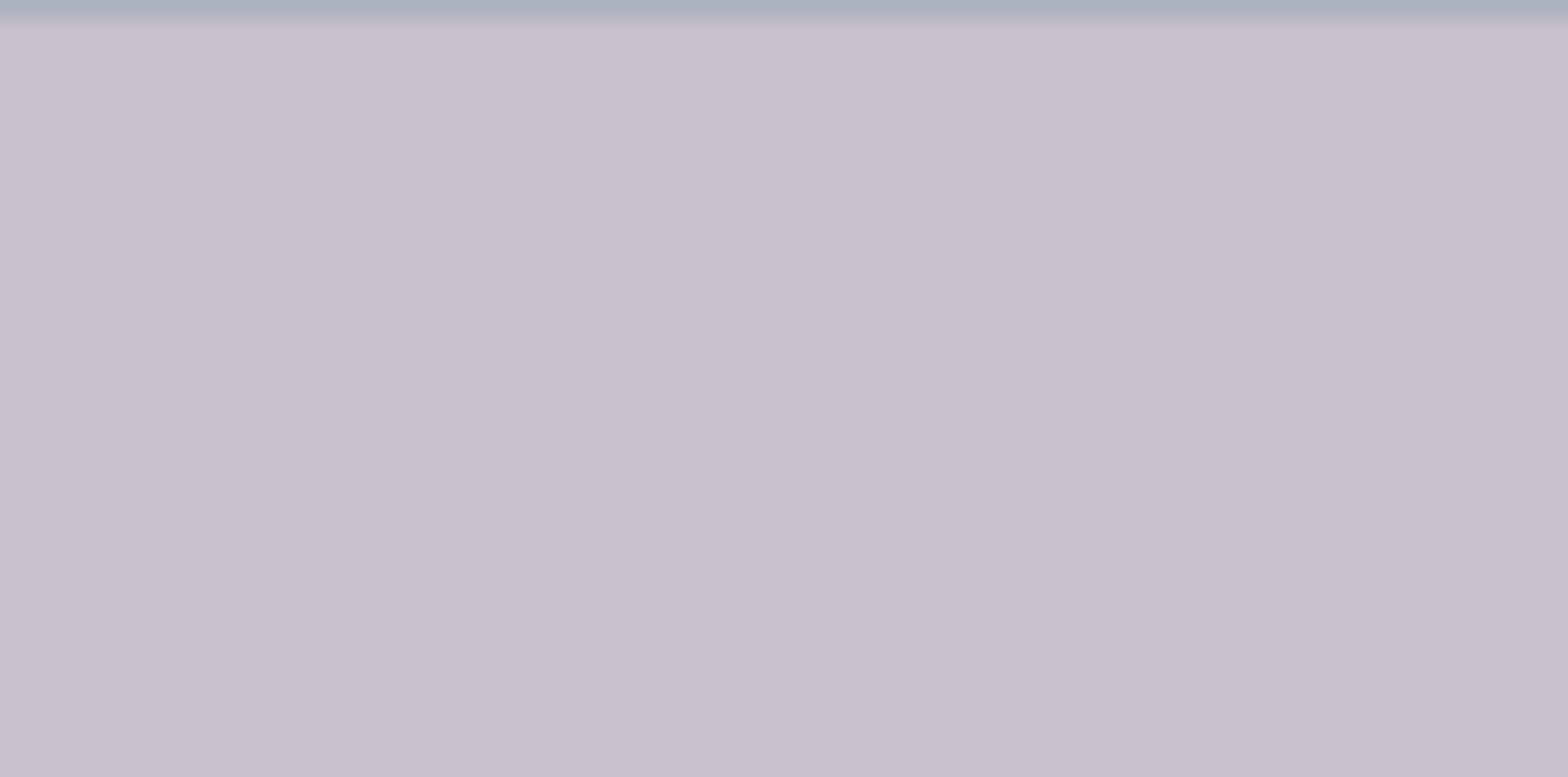



Arena romana

Verona

- Fastage wood-acoustical flooring with metal structure for orchestra pit
- Stage lighting with control system
- Lighting metal towers with moving lights



Medal Plaza Stage

winter olympic games

Torino

Design and supply of the steel and aluminium structures for the roof of the Medal Plaza Stage, for the Torino winter Olympic Games 2006.





Unipol Arena

Casalecchio di Reno

Supporting structure made of aluminium trusses with main grid of 22x20 m and carrying capacity of 40 tons about. Two side grids of 12x4 m, for audio and video equipment hanging, each with carrying capacity of 8 tons. Everything is moved by 28 motorized winches, 2 tons, necessary to guarantee a quick preparation. The fast and the safe positioning of the equipment (luminaires, spots, sound boxes, etc.) is an important technical contribution to switch over from sport space to shows and events space.



Mittelfest

Cividale del Friuli

Arena Alpe Adria

Lignano



- Fastage adjustable modular Platforms - 16 x 14 m
- Aluminium truss Milos Roofs MR3 16.00 x 14.00 m

Roof and towers with aluminium trusses
Fastage modular metallic platforms with height regulation: up to 150 cms.
Surface m 16x4



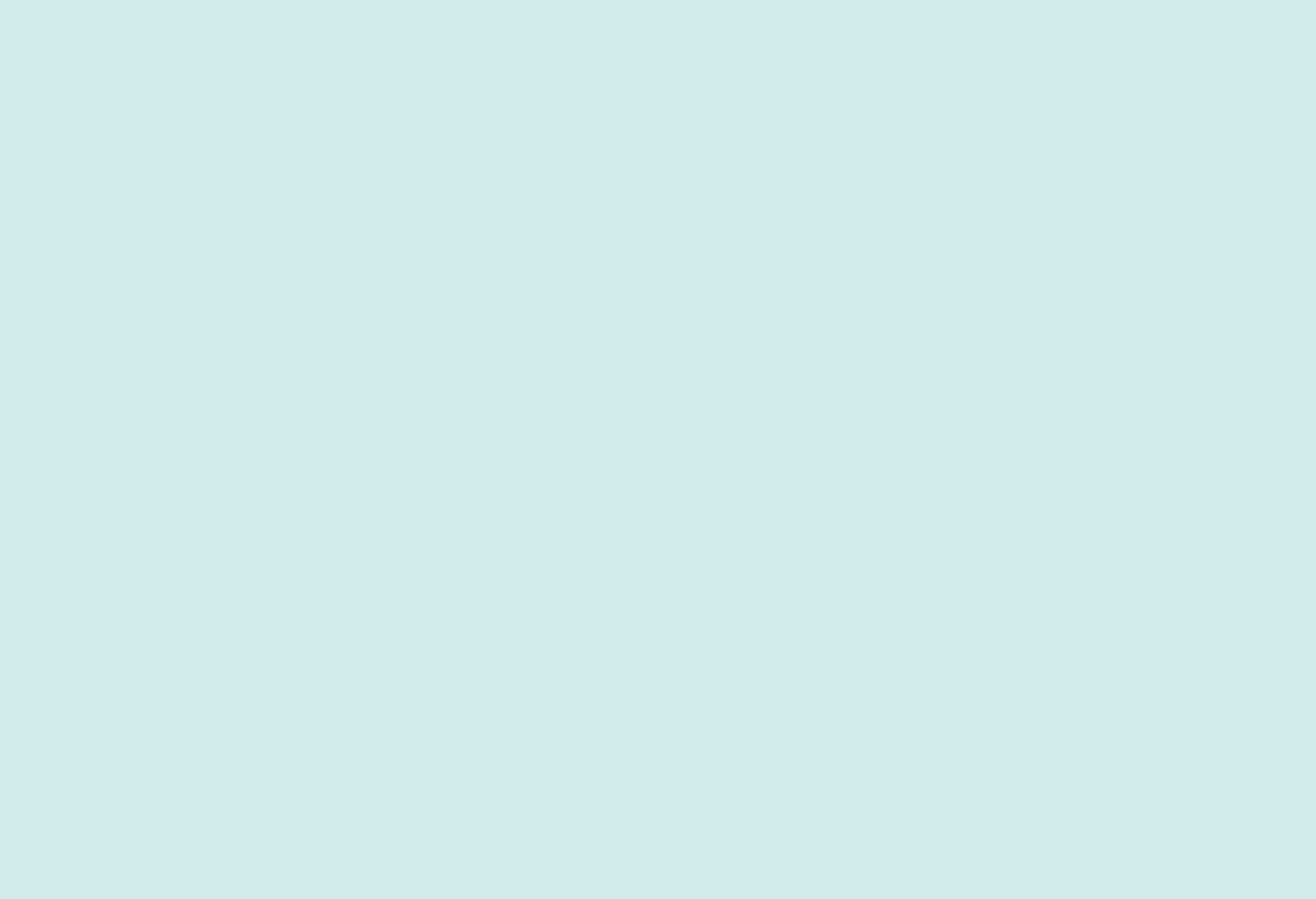

Cruise Ships:
Rigging & Curtains

Since
1948



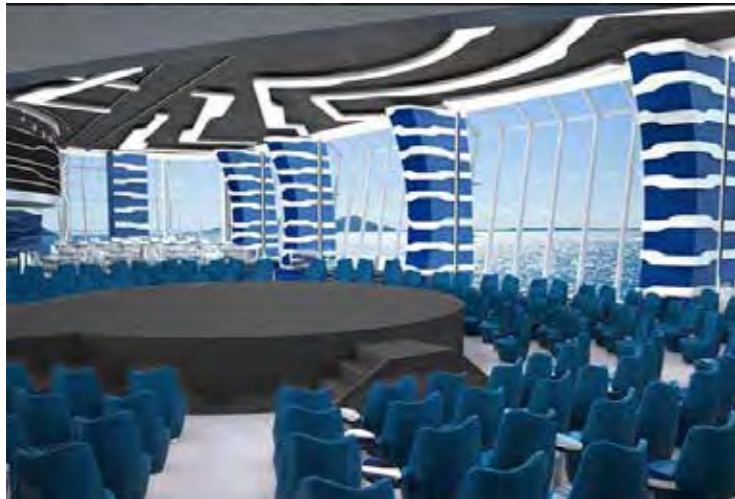

MSC Meraviglia: maiden voyage June 2017
 Supply and installation Aft Lounge area:
 - 13 motorised roller blackout blinds
 - 13 motorised roller blinds
 - Perimeter curtain manufactured in several pieces for the side stage areas complete with tracks.
 - Austrian curtain at bottom of Pandora box
 - Intermediate curtain in double voile black and silver inside Pandora box
 - Several masking curtains for rails, carousel structure, outside of all Pandora box area



MSC Bellissima: maiden voyage march 2019
 Sister-ship of Meraviglia conceived with the same equipment and curtain system, entirely in black colour for Aft Lounge Area. Further in Main Theatre stage, supply of Front curtain in green/blu color, velour backdrop and intermediate curtain in black velour and various maskings.

Carnival Vista: maiden voyage May 2016
 - Austrian backdrop curtain in the Grand Hall stage
 - Net Led Wall side maskings in the outdoor pool area



Wartsila – VIKING Jupiter Cruise: january 2019
 - Mechanism for movement of Led Wall in the swimming-pool area
 - Aft Lounge Front traveler curtain made in three layers: front side in white voile, the middle part in blue velvet and the back in fabric.

Wartsila – Costa Venezia Cruise: January 2019



Masque Lounge
 - Front traveler curtain in fabric reproducing buds in amethyst colour
 - Backdrop with star cloth effect curtain

Gondola Plaza
 - Front traveler curtain in blue voile light blue color and an underlayer in fabric

MSC

Meraviglia-Bellissima
 Grandiosa



Work in progress:
MSC Grandiosa: sister-ship of Meraviglia and Grandiosa - maiden voyage foreseen within end of 2019.
MSC Cruise: MUSICA – PREZIOSA – SPLENDIDA - ARMONIA
 Maintenance of the stage area, curtains and of the movement equipment on stage.

Seabourn

Ovation
 Seaview



Seabourn Ovation: maiden voyage on june 2018
 In 2018, Seabourn is introducing Seabourn Ovation, a sister-ship to the already prestigious Seabourn Encore. Seabourn Ovation represents another welcome stage in the evolution of small-ship cruising, which Seabourn pioneered and has consistently expanded and enriched. Both ships will deliver a wealth of new concepts, a fresh vision and a host of illuminating ideas to delight the world's most discerning travelers. Seabourn Ovation will be the second new ship to expand and build on the line's award-winning and highly acclaimed fleet of Odyssey-class ships, which revolutionized ultra-luxury cruising with enhanced accommodations and innovative amenities when they were introduced between 2009 and 2011. Sister ship Seabourn Encore was introduced in Singapore on January 7, 2017.

Warsila

Costa Asia-Viking



Seabourn Encore: maiden voyage December 2016
 - Backdrop curtain in velvet amethyst colour
 - Front traveler curtain in a special design velvet amethyst colour

Scenography

Decima is highly skilled in design, supply and install theatrical scenery for multipurpose sets and different performances, into Opera Houses, Drama Theatres, Ballet and Concert halls.

Our team is able to transform the ideas into reality, giving a technical aspect to what has been imagined for the show. We have skills to design and create the entire stage equipment, with different machines for special effects, enhancing the strength of each individual project. The spirit of the stage comes to life in creative and original solutions, meeting the practical and safety requirements both for technical operators and artists.



Since
1948

DECIMA
1948





DIE LUSTIGE WITWE (THE MERRY WIDOW) - LA FENICE - VENEZIA

Fondazione Teatro La Fenice together with Fondazione Teatro dell'Opera di Roma co-production.

Decima has reproduced three scenography for the Franz Lehár Operetta: a bank, a dance hall and an office, whole consisting of equipped walls on Wagons.

Printed curtain and glass walls design, based on sketches of Paolo Fantin scenographer.



AQUAGRANDA - LA FENICE - VENEZIA

50 years later, La Fenice theatre wanted to recall the tragic event of November 4th 1966 Venice flood, with the drama in music "Aquagranda", which inaugurated the 2016-2017 lyrical season on the fiftieth anniversary.



MACBETH - LA FENICE - VENEZIA

Once again La Fenice theatre, has required our Company Skills for some Scenography of the "Macbeth" by Giuseppe Verde, opening Opera of the new season.

Decima has created the lateral bearing structures together with the supporting track for lighting devices.



L'ITALIANA IN ALGERI - Sailing Ship - LA FENICE - VENEZIA

L'italiana in Algeri is an operaticdramma giocoso in two acts by Gioachino Rossini to an Italian libretto by Angelo Anelli, based on his earlier text set by Luigi Mosca.

Decima has created the Sailing Ship scenography, for this production.



GIULIETTA E ROMEO - TEATRO ALLA SCALA - MILANO

Decima has developed a very big book scenography with 200 m2 of pages - movable cushioned dance floor, covered with a dance mat, metal structure with electromechanical drive devices for 180 ° rotation of one of the two pages - the whole installed on pivoting wheels with pneumatic lifting movement.



DON GIOVANNI - RADIO CONTROL MOVABLE WAGONS

2 radio-controlled monoliths projected for free movement on stage with movable deflectors and luminous screens.



MADAMA BUTTERFLY – Sloping Floor - TEATRO ALLA SCALA - MILANO

For this Puccini Opera production, Decima has developed a Sloping moving Floor, with wagons in several modules, included upper tracks for sliding movement.



TRISTAN UND ISOLDE – Radio Controlled Vessel Wagons - TEATRO ALLA SCALA - MILANO

For this Wagner Opera production, Decima has developed five synchronized Radio-Controlled Wagons for the movement of a Vessel.



I PAGLIACCI – Van electrification - TEATRO ALLA SCALA - MILANO

For this leoncavallo Opera production, Decima has electrified four vintage little vans.



TENEKE – Mobile Support Structure - TEATRO ALLA SCALA - MILANO

For this Fabio Vacchi Opera production, Decima has developed a Mobile Support Structure, for the sculpture designed by Arnaldo Pomodoro.



TURANDOT – Movable Set Towers - TEATRO ALLA SCALA - MILANO

For this Giacomo Puccini Opera production, Decima has developed a complex of seven towers to support the Scenography. The 3,50 meters vertical movement is activate by electromechanical Spiralift System actuators.

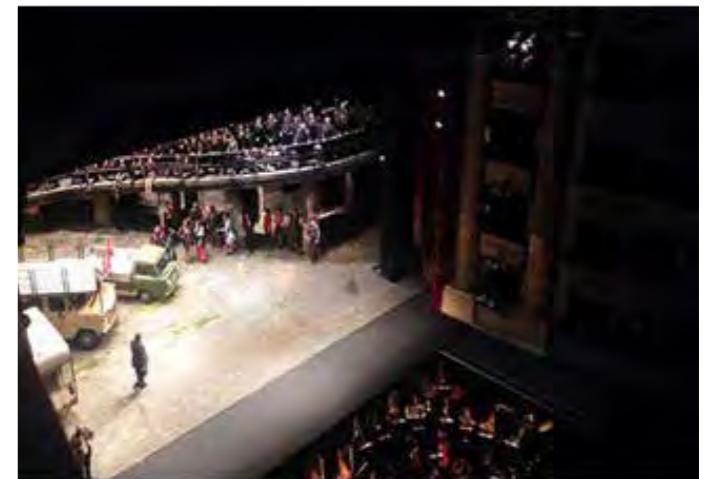

SIEGFRIED – Movable Wagons - TEATRO ALLA SCALA - MILANO

For this Richard Wagner Opera production, Decima has developed three Movable Wagons activated by electromechanical actuators, with additional sliding wall, based on the Director's design.

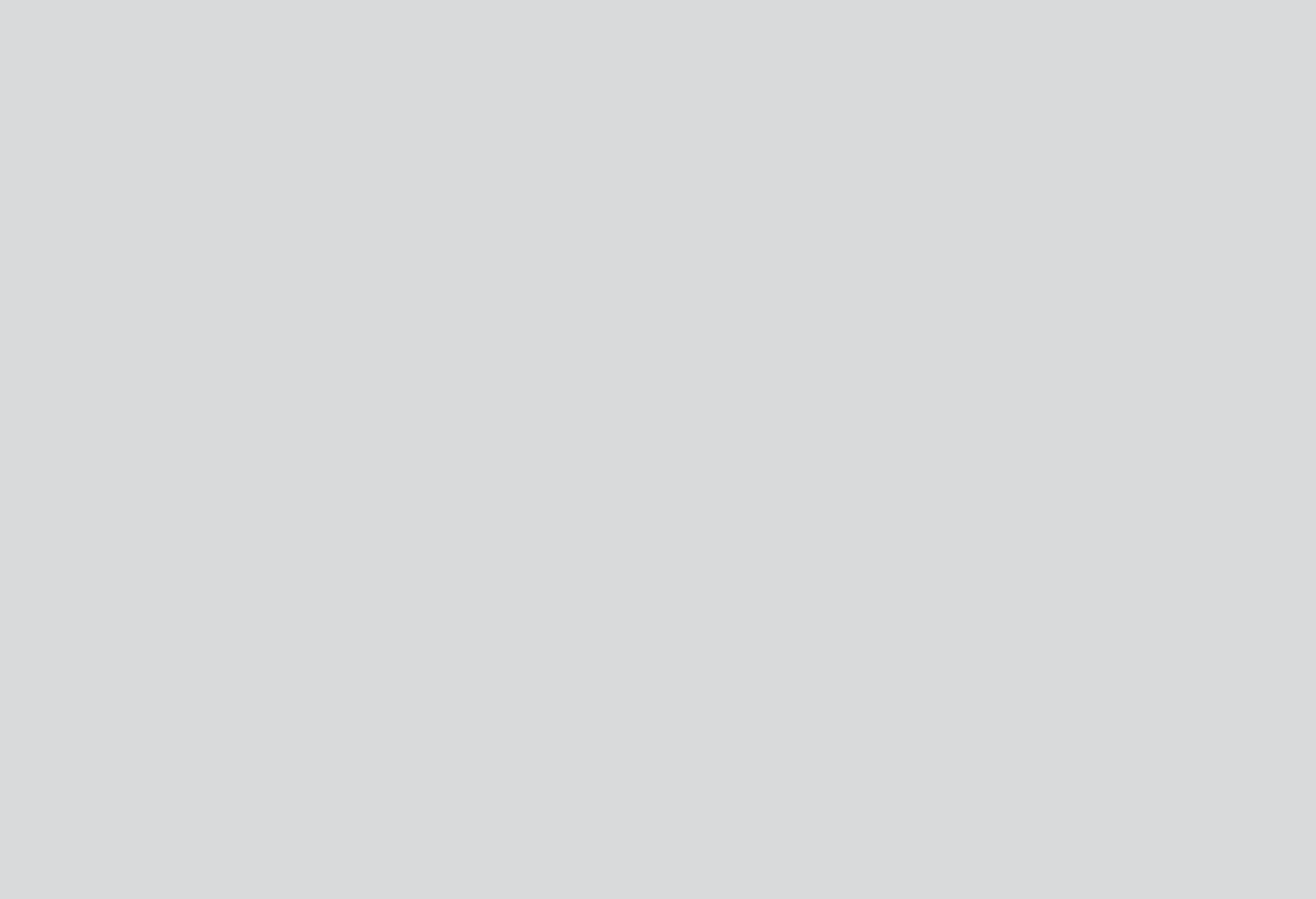

Acoustic Orchestra Shells

DECIMA
1948

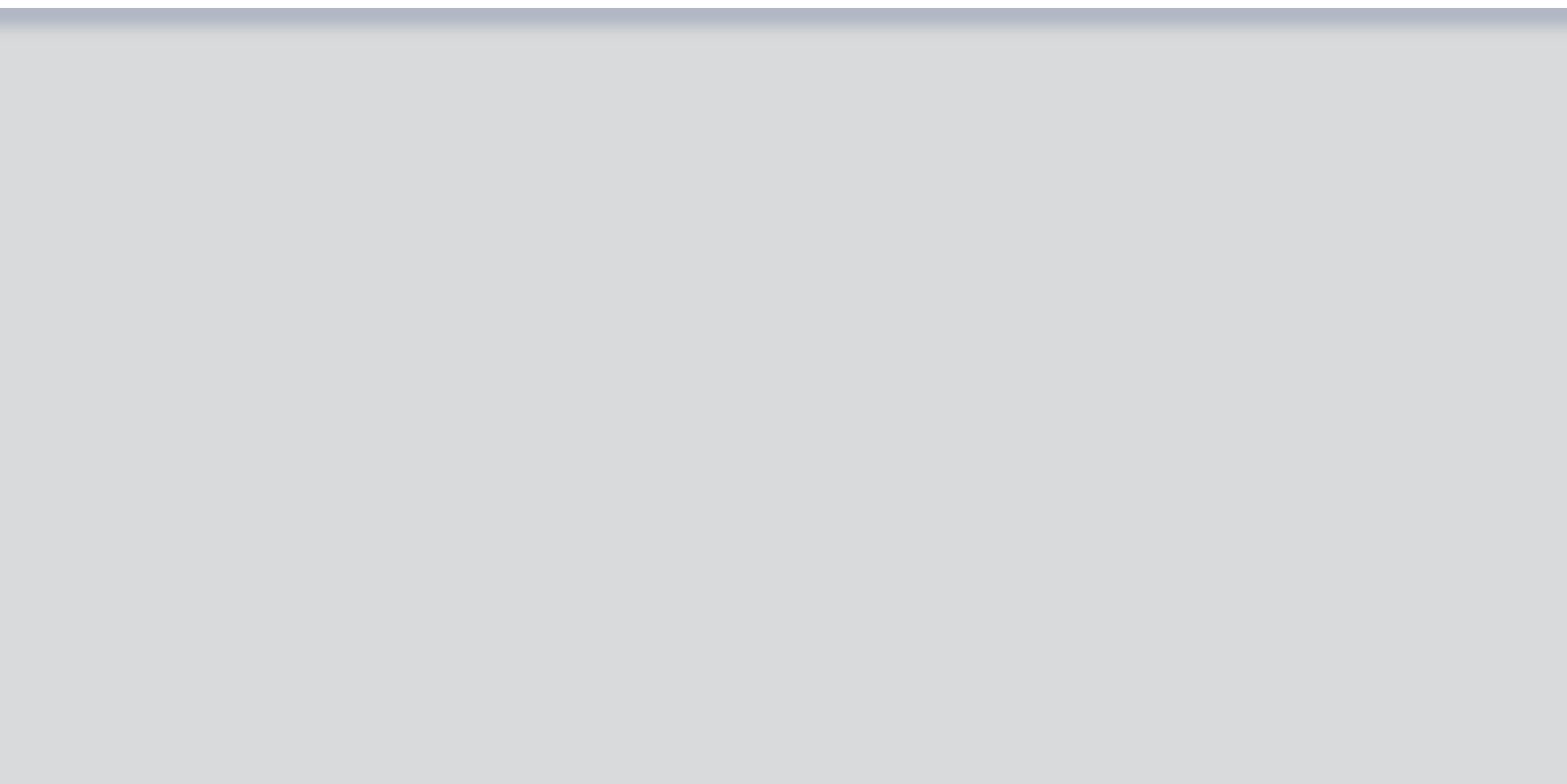

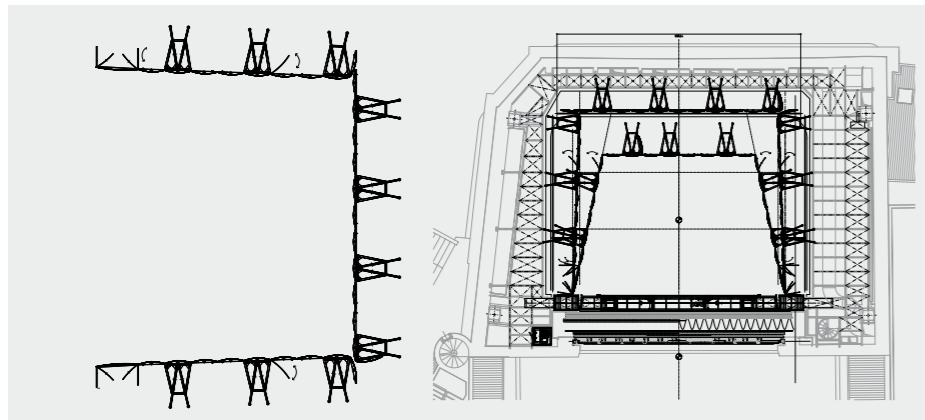

Acoustical Shell Granteatro

Modular elements adaptable to different configurations.
 Self-supporting movable Towers, complete with stabilizers, weights and swivel rubber wheels.
 Sound-diffusing convex surfaces of plywood curved wood. Solid wood framework panel.
 Aluminium tower supporting frame.
 Reduced dimensions for storage.

Ceiling composed by a series of modular wooden panels, connected to aluminium trusses, supported and variable oriented by Rigging.

Ceiling: Lighting application on demand
 Tower: Piano Doors on demand
 Usually plywood essence: Okoume, Birch and poplar;
 other timber on demand
 Fire retardant wooden materials,
 Euroclass (Bs2-d0) reaction to fire.

Typical Layout

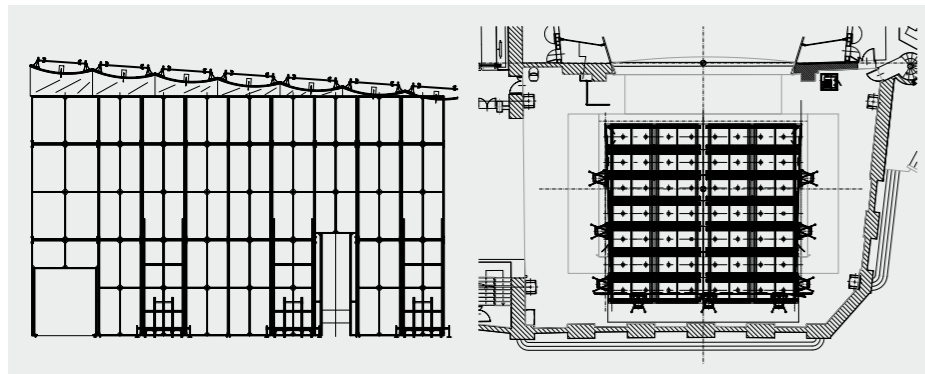

Tower assembly scheme

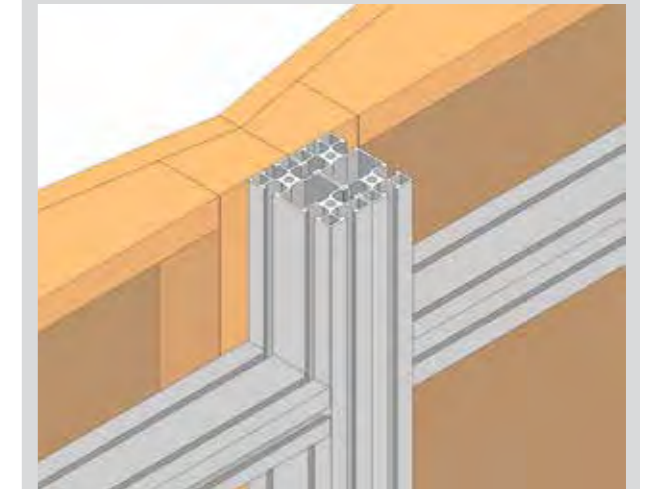
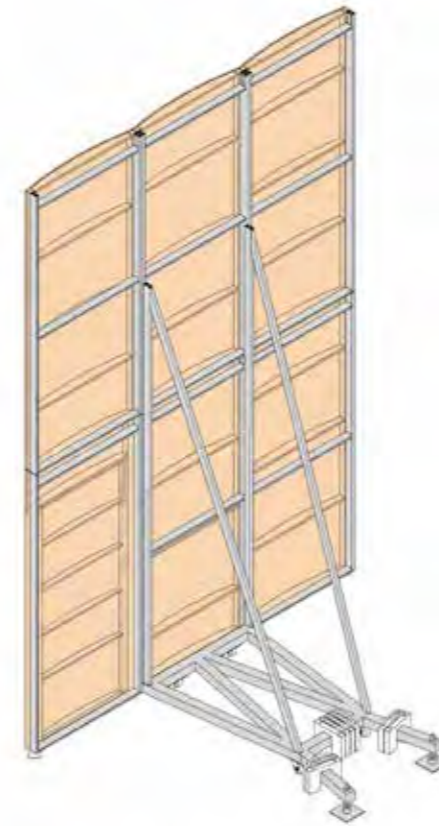

Aluminium structure with wooden panel assembly scheme

Granteatro

Orchestra Shells

Tower Modules

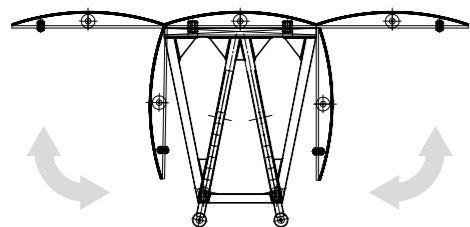

Side panels movement scheme, when opened and closed including stabilizers movement; the trolley will be moved by an electric fork lift

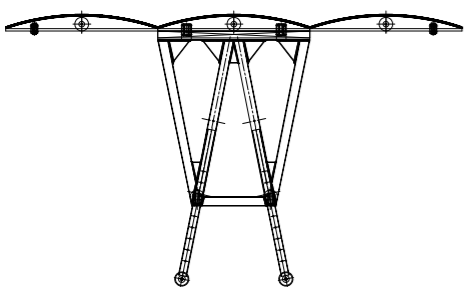

Side panels during the operation (opened panels) including stretched stabilizers



Ceiling Assembly Scheme

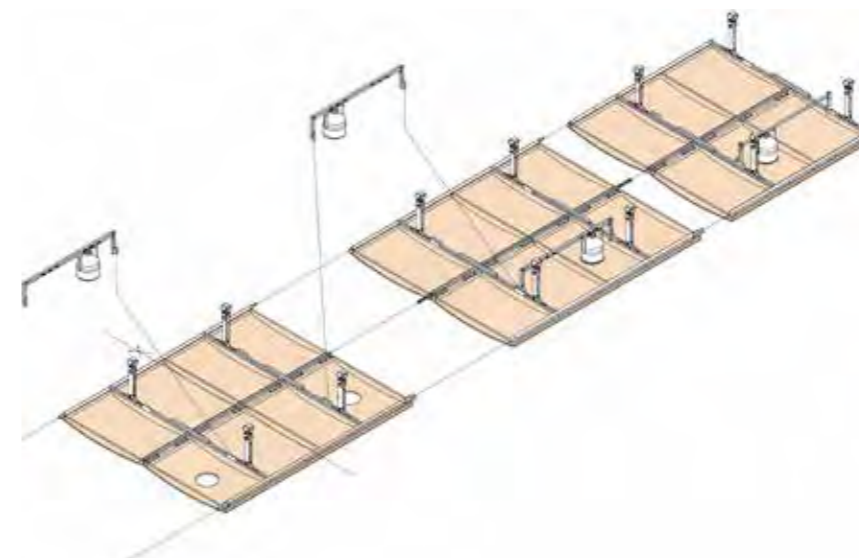



Modular elements adaptable to different Configurations such as:

- Orchestra and chorus
- Orchestra only
- With use of the proscenium

Self-supporting movable Towers, complete with stabilizers, weights and swivel rubber wheels. Sound-diffusing convex surfaces of plywood curved wood. Solid wood framework panel. Aluminium tower supporting frame. Reduced dimensions for storage.

Ceiling composed by a series of modular wooden panels, connected to aluminium trusses, supported and variable oriented by Rigging. Solid wood framework panel.

Ceiling: Lighting application on demand
 Tower: Piano Doors on demand Usually plywood essence: Okoume, Birch and poplar; other timber on demand
 Fire retardant wooden materials, Euroclass (Bs2-d0) reaction to fire.

Ceresium

Acoustical Shell Ceresium

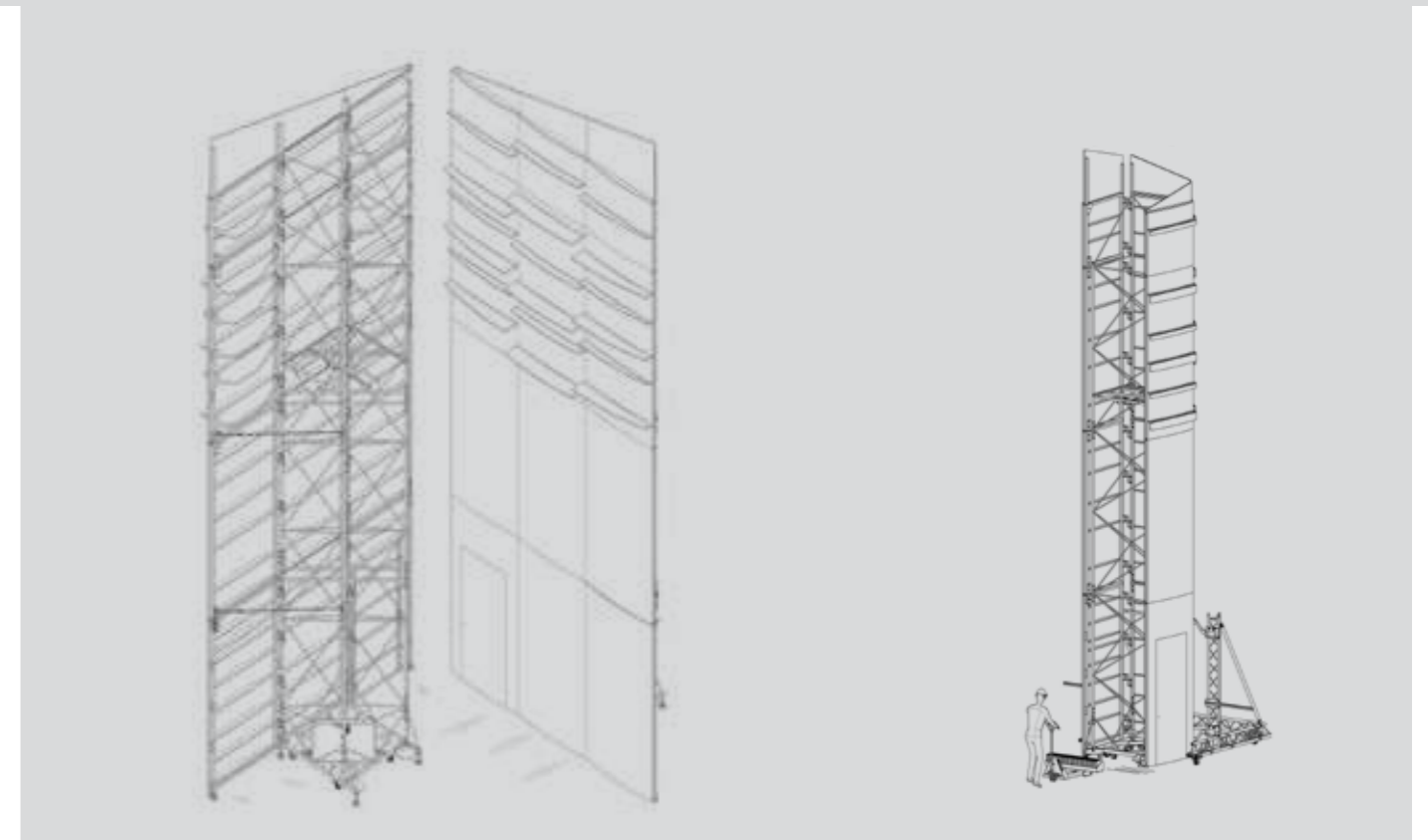
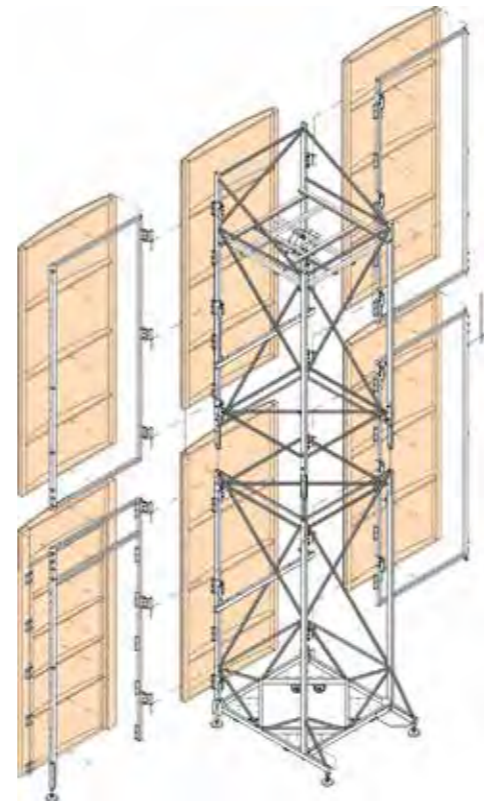



Acoustic shell Haydn

Modular elements adaptable to different configurations.
 Wooden walls hookable together and supported by adjustable scenery braces.
 Plywood wall surfaces in panels with different orientation in order to reach a better sound-diffusing.
 Walls are connected to the roof with adjustable tilted items.
 Ceiling is composed by modular wooden panels, suspended and adjustable by means of motorized rigging.
 Reduced dimensions for storage.
 Usually plywood essence: Okoume, Birch and poplar; other timber on demand
 Fire retardant wooden materials, Euroclass (Bs2-d0) reaction to fire.



Haydn

Orchestra Shells

Piazza Teatru Rjal Valletta - Malta

Layout

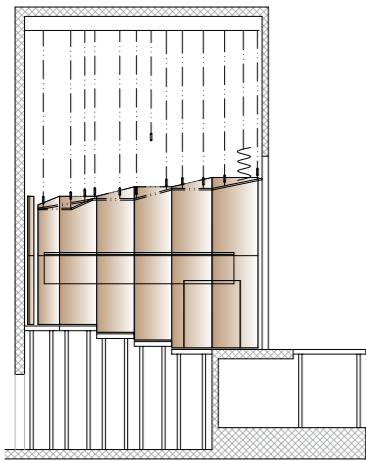

Scheme of walls & ceiling

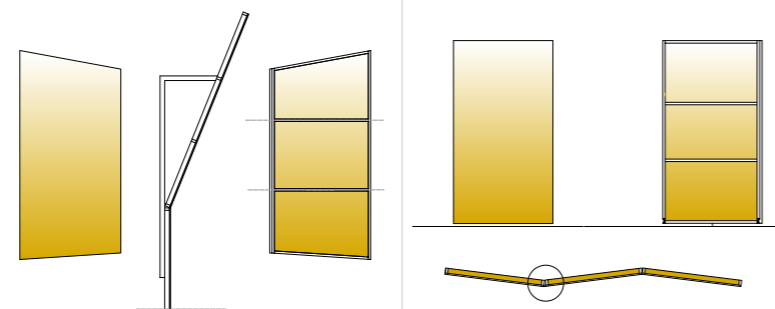

Upper side wall scheme

Lower side wall scheme



Renzo Piano's open-air theatre Piazza Teatru Rjal built upon the ruins of the Royal Opera House in Malta

- Supply of wooden panels to form the acoustic chamber in the perimeter of the square
- Inverted Spiralift® application units for the first time in Europe.

In an almost 1000-seat auditorium
 - requiring a variety of configurations for opera, dance, theatre and concerts
 - two orchestra lifts were installed inversely, that is, with all their mechanical and electric components anchored underneath the mobile platform, as opposed to the bottom of the pit. By doing so, it was possible to minimize the risk of them being submerged in a water-filled pit and suffering damage.



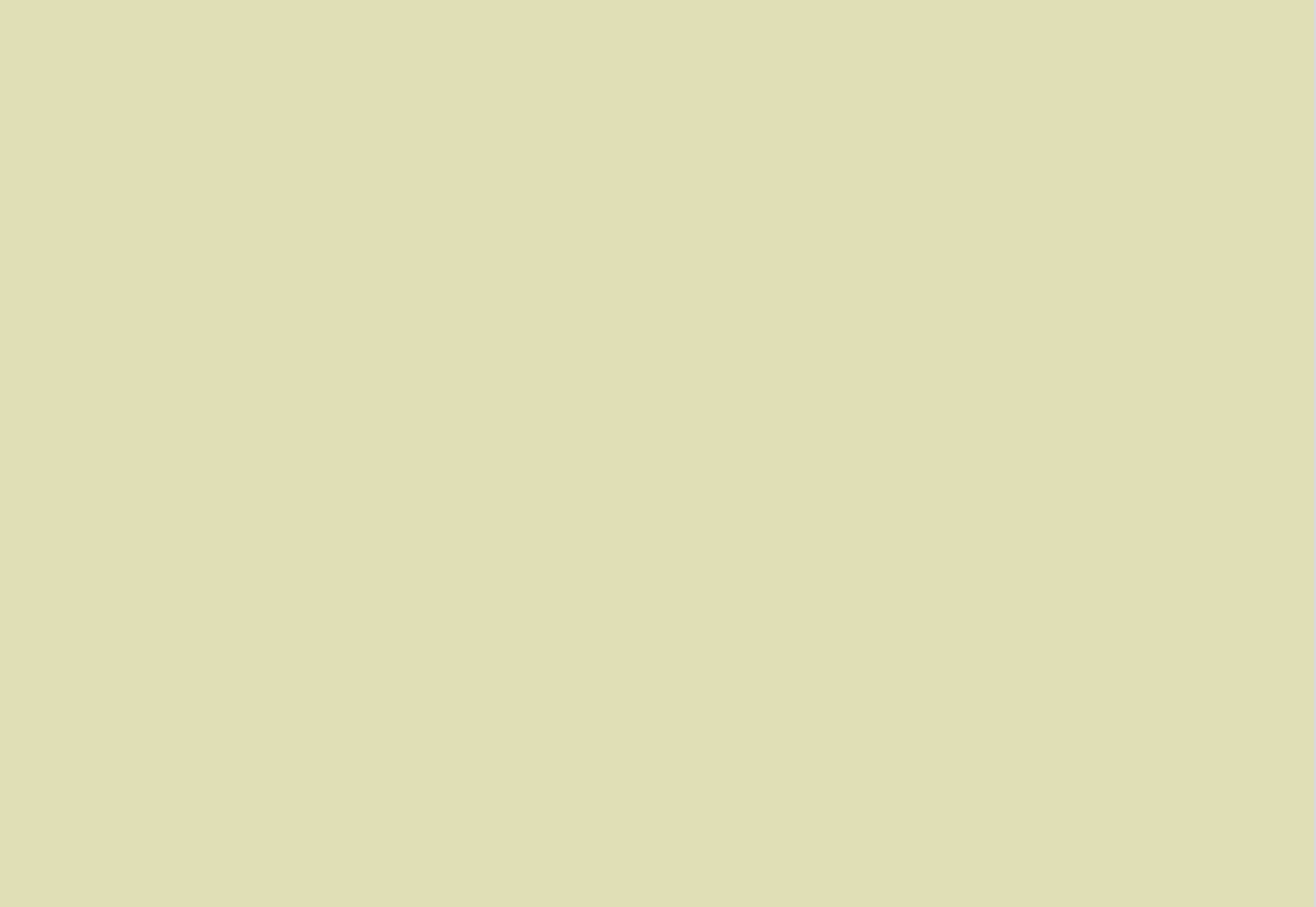

Products

DECIMA
1948

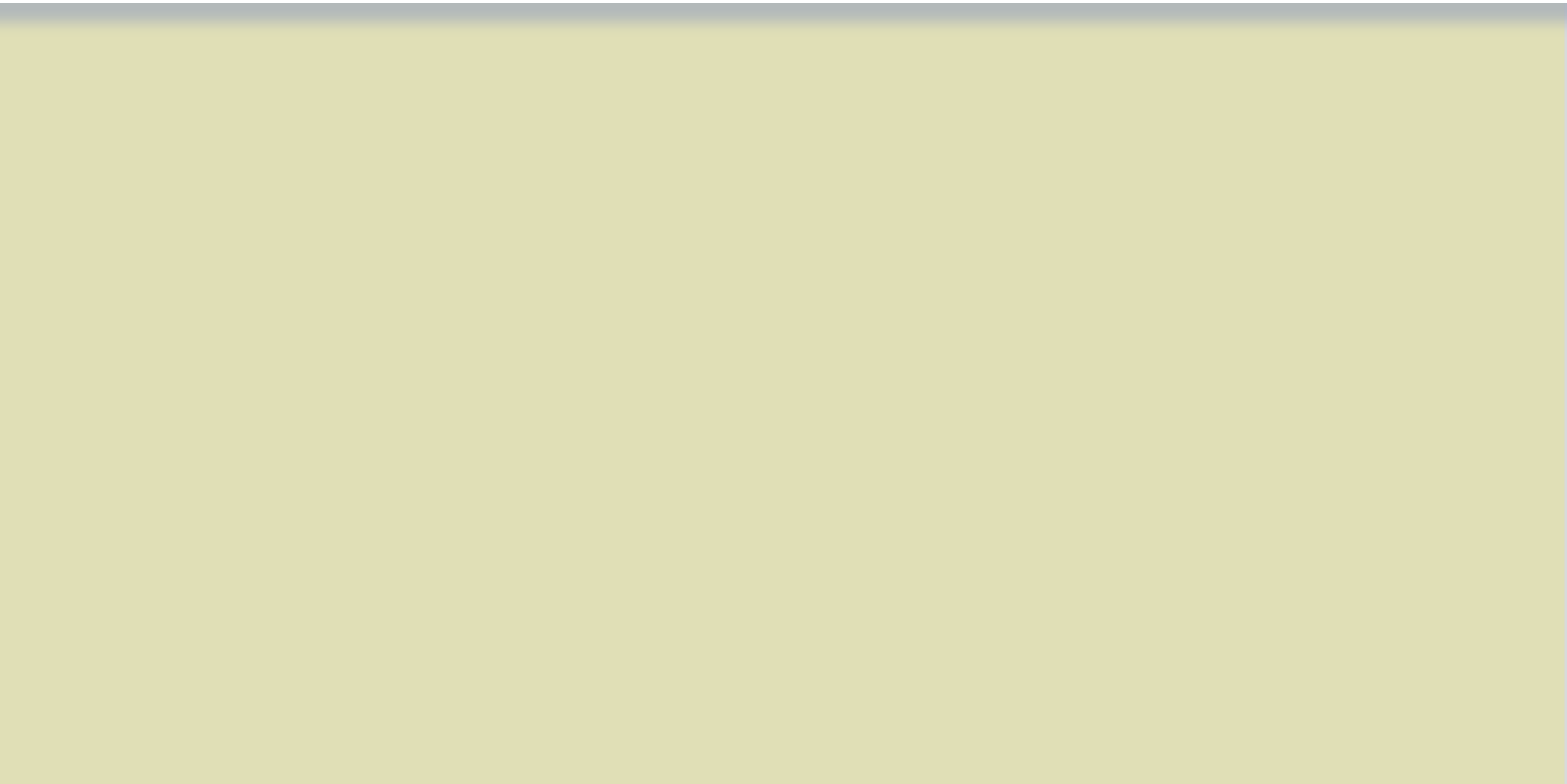



FLEXSEAT

FlexSeat is a modular system of platforms allowing to hide away the seats under the floor, and changing like this, very quickly a multi-purpose hall. Through a sequence of movements carried out by electromechanical actuators, each module can hide-away or bring out the seats. The FlexSeat 2.0 system has been designed expressly for the seat S9.9 Synchron.

A motion control system allows to control all the modules at the same time, or to carry out partial open-close according to the presets established by the Customer. This allows to create halls partially occupied by seats and leave spaces for catering and/or for the disabled persons.

The system can be installed on a flat surface or on lifting mechanisms that can transform a hall on a flat surface into one with steps.

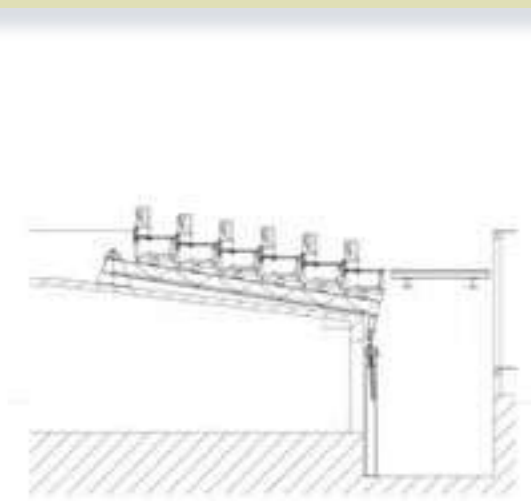

Stage curtains

DECIMA
1948

"Canadian smoke" style tailoring



Roma - Teatro dell'Opera

Two front Curtains, the first velvet Tableau with diagonal open close and the second velvet Traveler with horizontal open close. One Drapery Border with draped velvet decorated with two-colours passementerie in old-rose and brown like the original. Careful restoration of the original coat of arms and re-installation on the proscenium Drapery Border.



Faenza – Teatro Masini

House Traveler Curtain and proscenium Drapery Border, both made in 100% wool velvet, and decorated with two-colours passementerie blue and gold like the original. Remake of the city coat of arms with fabric of different colours, with strings and painted details.



Catanzaro – Teatro Politeama

House Traveler Curtain and proscenium Drapery Border, with draped velvet and decorated with fine golden passementerie composed by fringes and borders. Remake of the city coat of arms with embossed effect in fabrics of various colours, with strings and painted details.



Baku – Azerbaijan State Theatre of Musical Comedy

House Curtain and Drapery Border with draped velvet and decorated with fine golden passementerie composed by fringes and decorative band.

Stage Curtains



Ascoli Piceno
Teatro Ventidio Basso

House Traveler Curtain and proscenium Drapery Border with draped velvet and decorated with fine golden passementerie, composed by fringes and borders. Remake of the city coat of arms with fabric of different colours, with strings and painted details.



Napoli – Teatro Bellini

House Traveler Curtain in red draped velvet, decorated with fine golden passementerie, composed by fringe and double border. Proscenium Drapery Border in three layers: the first red, widely draped, the second in old-rose velvet with the reproduction of 3 lyres with borders made of flowery Greek frets, based on an original drawing of 1800. The third layer also in red velvet with lower border variously shaped and decorated with fringe.



Verona – Teatro Filarmonico

House Tableau Curtain made in 100% special colour linen velvet, decorated with golden fringe and wooden elements, reproduction of original flowery decoration band in gold-leaf metal yarn fabric. Draped proscenium Drapery Border, embellished with strings, bows and fringe.



Torino – Teatro Carignano

House Traveler Curtain in velvet and 3 different Drapery Borders draped and decorated like the original with fringe, strings, bows and decoration band with golden passementerie.



Badia Polesine - Teatro Sociale

Main Curtain Decoration with several gold-foil fabric flowers and Lurex fringe. The trimming Lurex braid is made inspired by an original decoration of the theatre.



S. Vito al Tagliamento
Teatro Arrigoni

Main Curtain Decoration with several gold-foil fabric flowers and Lurex fringe. The cornucopia decoration, embroidered in the Centre of the Curtain, is inspired by an original adornment of the theatre.



Torino - Teatro Carignano

Remake of Curtian Lurex fringe and trimming Lurex braid, similar at the original.



Stage Curtains



Venezia – Gran Teatro La Fenice

Decoration with 1.100 gold-foil leather flowers, wood and silk embroidery, fringe of metal twisted thread and wooden silvered in "Mecca".



Stage Curtains and draperies decorations



Fiorenzuola d'Arda – Teatro Verdi

Remake of the original drawing with embroidery directly on the velvet with golden silk and lurex yarns.





Detail of the coat of arms of the Rimini Municipality, embroidered on the Drapery Border.

Rimini - Teatro Galli



Reana del Royale
Auditorium Comunale



Spilimbergo - Teatro Miotto



Detail of the Lurex trimming decoration of Curtain and Border, during the embroidery phase.



Carpi - Teatro Comunale

Prototype of the coat of arms of the Carpi Municipality, embroidered and painted on the Drapery Border.



Moscow - Little Bolshoi

Decorative trimming embroidered on the velvet traveler Front curtain.



Samples of handmade Lurex decorative trimming for curtain and drapes embroidery and pendants for the lower part of the curtain. Decorative design remaking of the original decorative curtain. Manufacturing embroidery system on velvet, or as an application padded in relief.



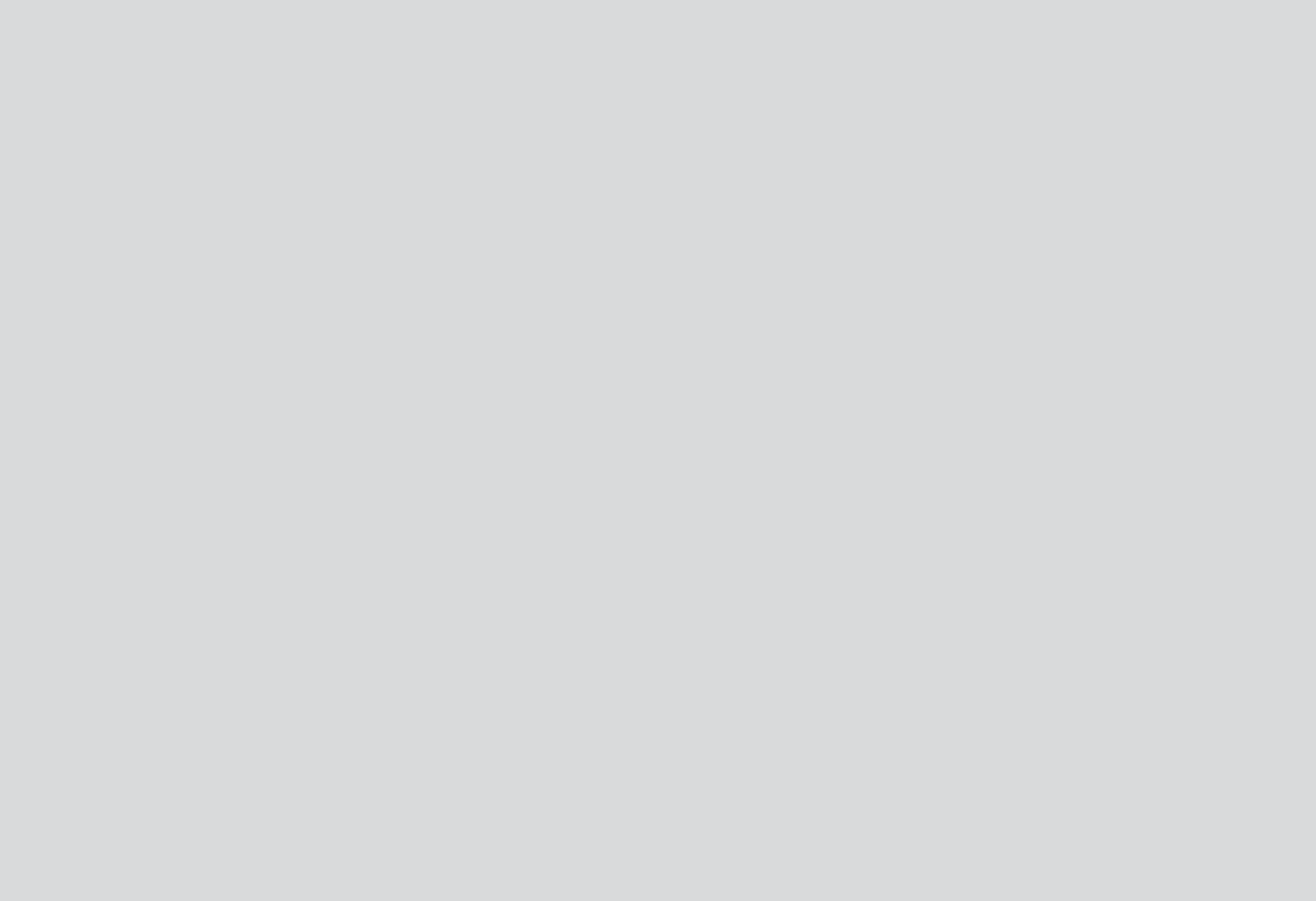

Stage Technology

DECIMA
1948

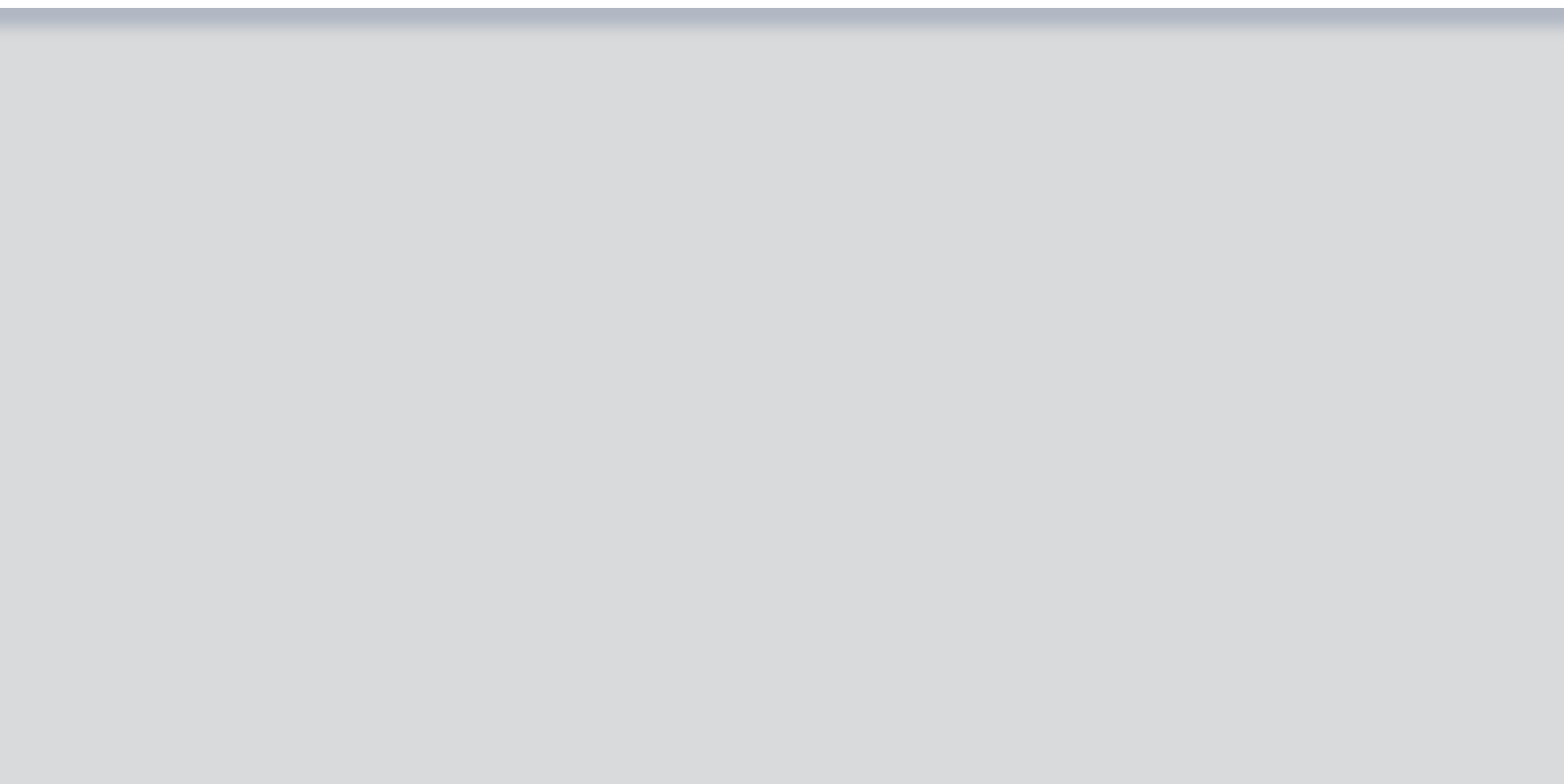

Stage Machinery: Rigging & Staging

Stage grid system



Stage hoists with variable speed **Liftech** model (Load 500 Kg.)



Movable stage hoists with variable speed (Load: 1.000 kg)

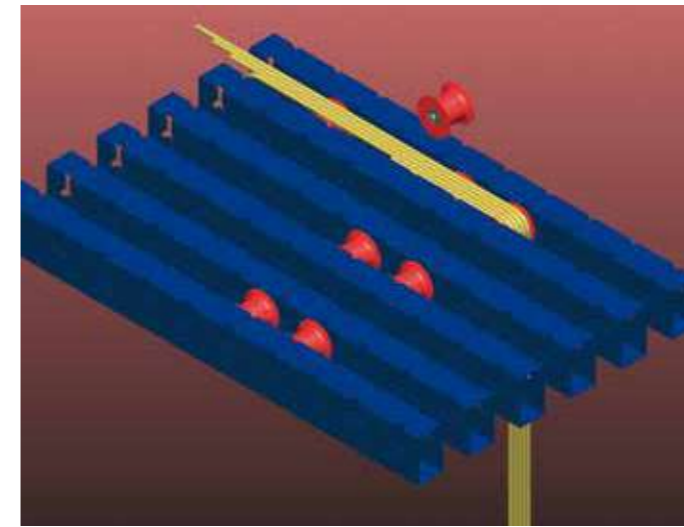

A) PRACTICABLE GRID MOD. EASY GRID

The grid is assembled on the support structure with a set of steel box profiles painted with epoxy powders, provided at the upper corners with slots which assure the quick, solid insertion of reels and pulleys. The alternation of profiles and slits, both of 60 mms, allows the preparation of stage riggings every 120 mms

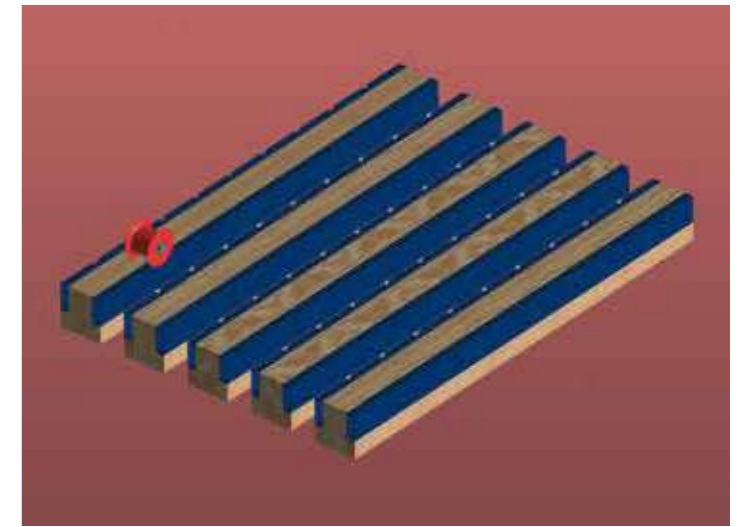

B)

The alternative grid with the element with wooden central part and 2 side parts with steel box profiles with slots at the upper corners

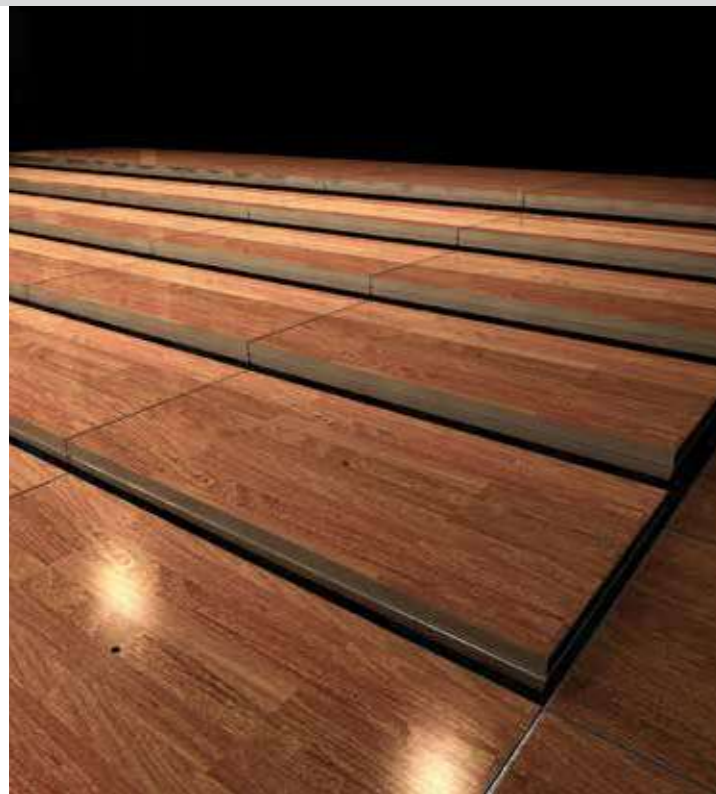

Mobile stage platforms



Mobile orchestra platform with **Spiralift** system

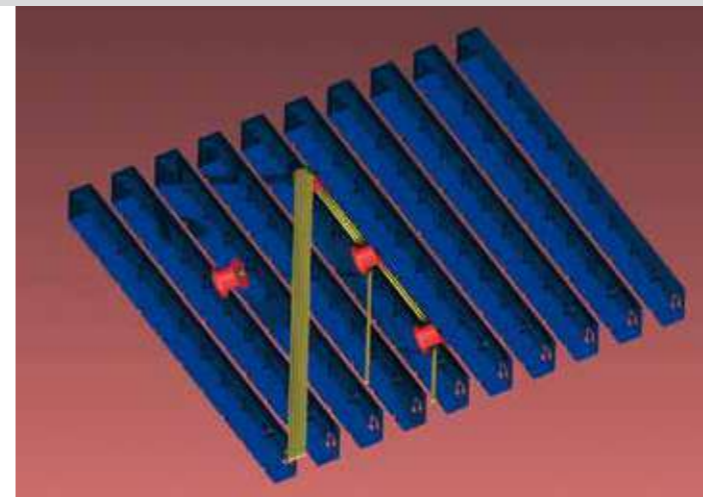

C) NON PRACTICABLE GRID MOD: EASY GRID

Grid with same characteristics of the practicable grid, but with box profiles assembled under the support structure. The slots are perforated in the lower corners of the profiles



D)

Details of realized grid in Teatro Regionale - Aosta

OPTIONS:
other dimensions
of box profiles are
available

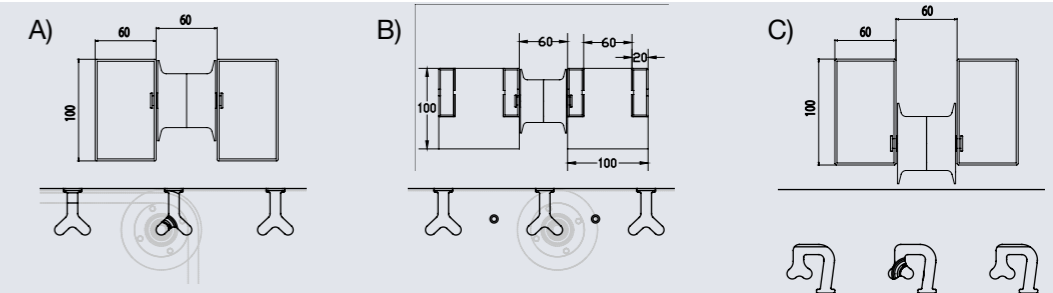

Motorized Stage Hoists



Motorized stage hoists, multi-ropes suitable for movement of scenes in big theatres with wide forestages and high stage towers, composed by the following parts:
 brushless type motor
 hydraulic braking system with double shoes disc brake
 brakes control sensor
 single PLC control mounted on the hoist
 load detection module
 sensor for detection of slack ropes
 double rotating multiturn limitswitch system
 control sensor for breakage of rope guide
 absolute encoder
 Ethernet control
 Applied regulations: BGV C1



Technical Features Liftech	
Speed	from 0.001 to 60 m/min
Diameter of steel rope	6 mm
Travel of the load bar	25 m
Synchronization	+/- 1 mm
Acceleration	1.5 m/sec ²
Precision in repeating the operation	+/- 1 mm electric positioning +/- 1,5 mm mechanic positioning

LT-100V		LT-75V		LT-50V	
Maximum carrying capacity	1.000 kg	Maximum carrying capacity	750 kg	Maximum carrying capacity	500 kg
Number of ropes	5/6	Number of ropes	5/6	Number of ropes	5/6
Self weight	600 kg	Self weight	550 kg	Self weight	470 kg
Motor power	15 KW	Motor power	11 KW	Motor power	7 KW

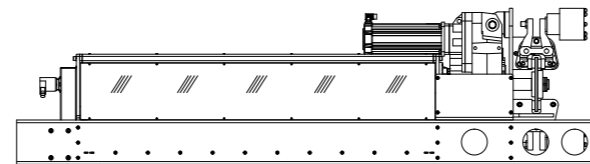

High speed multiropes hoist

Technical Features Super Liftech

Speed	from 0.001 to 120 m/min
Diameter of steel rope	8 mm
Travel of the load bar	30 m
Synchronization	+/- 1 mm
Acceleration	1.5 m/sec ²
Precision in repeating the operation	+/- 1 mm electric positioning +/- 1,5 mm mechanic positioning

SLT-150V	
Maximum carrying capacity	1.500 kg
Number of ropes	6-7
Self weight	800 kg
Motor power	52 KW

SLT-100V	
Maximum carrying capacity	1.000 kg
Number of ropes	6/7
Self weight	750 kg
Motor power	37 KW



Motorized stage hoists, multi-ropes suitable for movement of scenes in small and medium theatres where the variable speed lifting is required, composed by the following parts:
 asynchronous double-brake motor
 single PLC control mounted on the hoist
 load detection module
 sensor for detection of slack ropes
 double rotating multi-turn limit switch system
 control sensor for breakage of rope guide
 absolute encoder: optional
 Ethernet control: optional
 Applied regulations: BGV C1

Technical Features	
Speed	from 0.001 to 30 m/min
Diameter of steel rope	6 mm
Travel of the load bar	22 m
Synchronization	+/- 1 mm
Acceleration	1.5 m/sec ²
Precision in repeating the operation	+/- 1 mm electric positioning +/- 1,5 mm mechanic positioning

LTL-35V		LTL-50V	
Maximum carrying capacity	350 kg	Maximum carrying capacity	500 kg
Number of ropes	4	Number of ropes	4/5
Self weight	350 kg	Self weight	400 kg
Motor power	2 KW	Motor power	4 KW



LIFTECH

Single Point Hoist Double Rope

Double rope stage hoist suitable for use by Rental Companies, mounted and sliding inside a truss, it can be integrated in a ground support or a roof for live events.



LIFTSTART

Stage machine of easy construction, suitable for small or medium theatres, auditoriums, congress halls, etc. Electromechanical type working with winding of ropes on drum, intuitive and safe, complete of control board on the machine and portable pushbutton panel. Absolute encoder: optional Inverter: optional

Technical Features Lt-25Live

Maximum carrying capacity	250 kg
Speed	from 0.001 to 30 m/min
Ropes	2
Diameter of steel rope	5 mm
Travel of the load bar	20 m
Synchronization	+/- 1 mm
Acceleration	1,5 m/sec ²
Motor power	3 KW
Precision in repeating the operation	+/- 1 mm electric positioning +/- 1,5 mm mechanic positioning
Braking system	double braking system on the fast shaft

Technical Features Liftstart

Fixed speed	up to 10 m/min
Diameter of steel rope	6 mm
Travel of the load bar	15 m

LS-50

Maximum carrying capacity	500 kg
Number of ropes	4
Self weight	250 kg
Motor power	2 KW

LS-35

Maximum carrying capacity	350 kg
Number of ropes	3/4
Self weight	220 kg
Motor power	1,5 KW

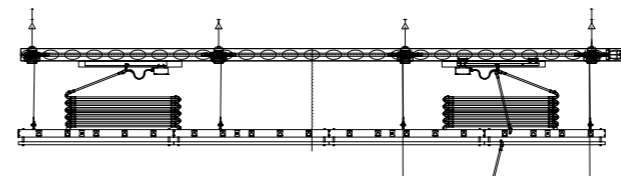

LST-35/8

Flybar lenght	6/8 m
Cable managing	8 SKT CEE 16A + DMX 512

LST-35/12

Flybar lenght	10/12 m
Cable managing	12 SKT CEE 16A + DMX 512

LST-35/16

Flybar lenght	14/16 m
Cable managing	16 SKT CEE 16A + 2 DMX 512

LSJ series COMMON FEATURES

PAYLOAD	UP TO 370 daN
TYPE OF SPEED	UP TO 8 mt/min
MAX TRAVEL	UP TO 15 meters
ROPES	4
ROPE DIAMETER	4-5 mm
MOTOR POWER	0,75-1,1 KW
LIMIT SWITCH	ROTARY 4 SWITCHES
ENCODER	RELATIVE/ABSOLUTE OPTIONAL
LOAD CELL	OPTIONAL
AUXILIARY SAFETIES	SLACK CABLE DETECTORS ON EACH SUPPORTING CABLES. CABLE-BREAK ON BOARD (OPTIONAL)

IN ACCORDANCE TO THE EUROPEAN MACHINERY DIRECTIVE, TO DIN 56950 BGV D8+ REGULATIONS AND WITH CE MARKING.

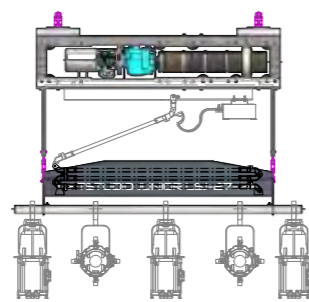
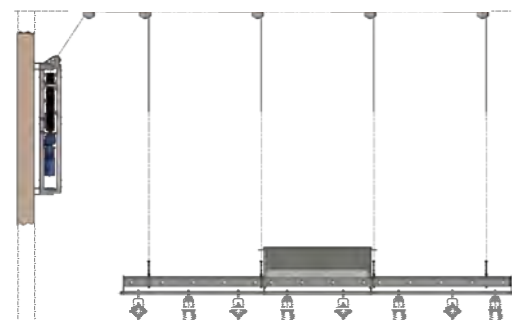

LIFTSTUDIO Jr.

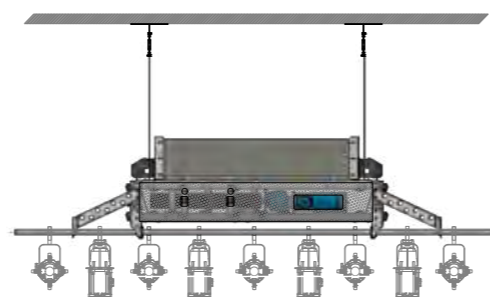
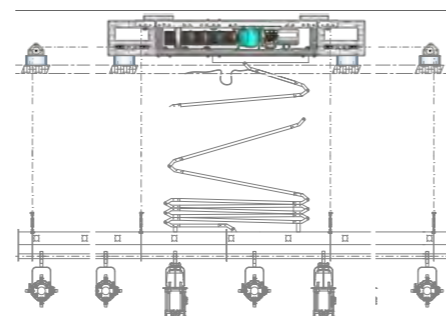

Rigging motion control



Motor Controller CURIO MC3

- Innovative multifunction terminal MC3 with colour touch screen. Very easy control and supervision thanks to chromatic associations. Navigation on wide display on full screen.
- Panel PC17" touch screen 1280x1024 pixel
 - Control keyboard
 - Led lighting
 - Constructed with strong aluminium section
 - DIN EN 573
 - Powder varnishing in black or light grey
 - Protection degree IP65 EN60529
 - CR profiled gasket
 - Mobile support on wheels

MC50 Portable motor controller

The control desk is complete of joystick, knobs, potentiometers, enlited pushbuttons, 3.8" display QVGA LCS b/w or 6.5" VGA TFT colours.

Safety equipment:

- E-stop pushbutton integrated through additional connection box.
- 2 integrated pushbuttons 3 levels, ergonomically studied for use with right or left hand, guarantee the maximum safety degree during the setup operations.



Modular platform with variable millimetric height



The upper frame is realized with an upper perimetrical aluminium profile and central transverses.
A mechanism with jackscrews transmits the vertical movement to four articulated legs and permits the variable millimetric height.
Four feet can compensate, up to 50 mm, the possible floor unevenness and are complete of hooking to the surrounding platforms.
The control is easily obtained by a standard electric or battery screwer inserted into the central hole of the floor.
Wood floor and different types available: standard, or fire-retardant, or water-proof

Dimensions:

240x120 cm height up to 1100 mm
200x100 cm height up to 1000 mm

Modular platform with legs of various heights

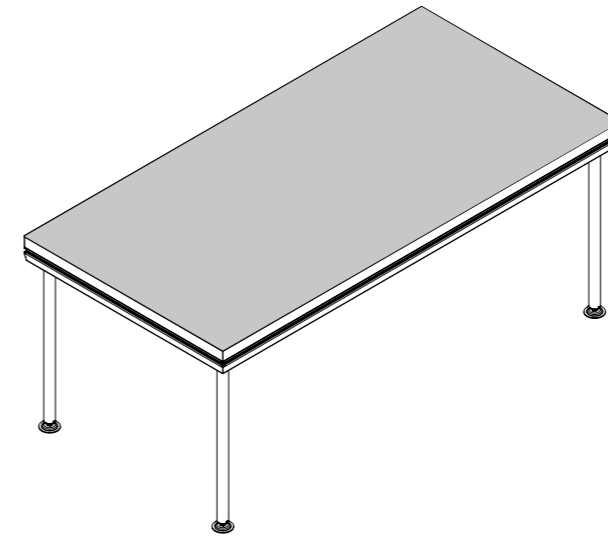

- upper frame with perimetrical aluminium profile
 - different type of floors: standard, or fire-retardant, or water-proof
 - jaw clutch, at the 4 corners under the floor, for quick clamping of the legs
 - legs: h. cm 20/40/60/80/100/120/140/160
 - telescopic legs: h. cm 80-100/100-140/140-160
- Options:** railings and stairs

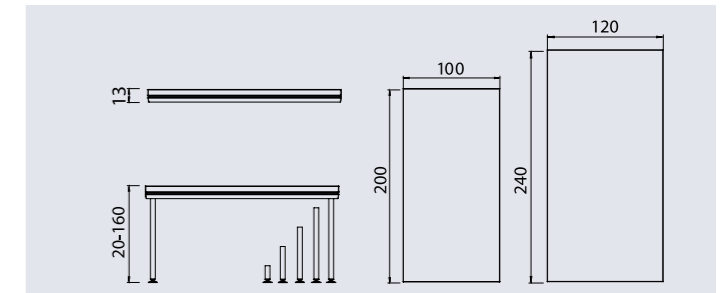

Flexdeck 200x100cms

With Legs in aluminium alloy diam. mm 48,3x4 (EN AW-6082T6)

H cm	≤80-100	101-60	161-180
Uniformly distributed load Kg/sqm	750	500	350

Flexdeck 240x120cms

With Legs in aluminium alloy diam. mm 48,3x4 (EN AW-6082T6)

H cm	≤80-100	101-160
Uniformly distributed load Kg/sqm	500	350

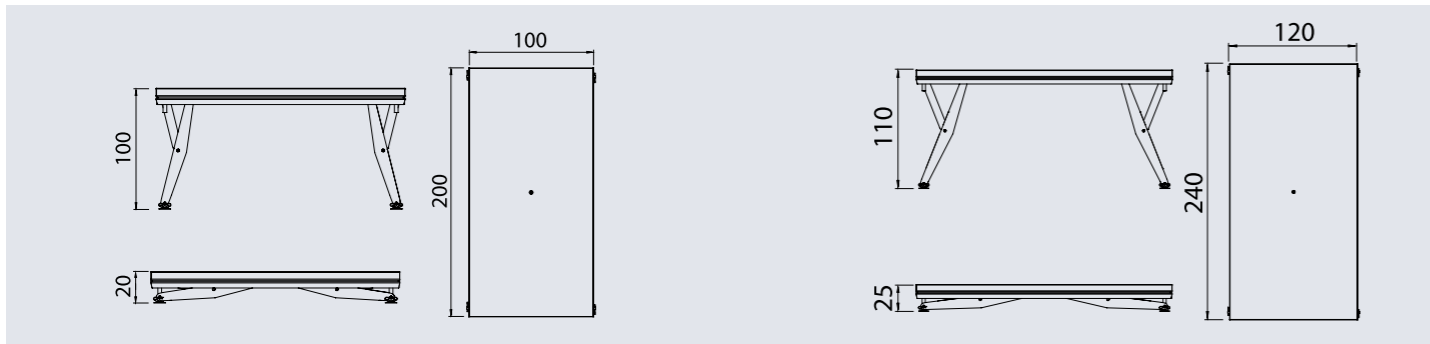

Flexstage 200x100cms

H cms	20	21-40	41-100
Uniformly distributed load Kg/sqm	750	500	750
Operator on platform	YES	YES	YES

Flexstage 240x120cms

H cms	25	26-41	41-110
Uniformly distributed load Kg/sqm	750	500	750
Operator on platform	YES	YES	YES



Control of vertical movement by means of a standard electric or battery screwer, introduced into a small central hole in the floor.

Stages with modular Platforms for indoor and outdoor use



These platforms are suitable for fixed stages and, in particular, for temporary installations, thanks to their easy storing and transport due to the components of reduced volume and weight, and to an easy assembling obtained with a quick hooking of all the components and to the height adjustment made, by means of a standard electric or battery screwer, on the top of the telescopic legs.



Height adjustment of the telescopic leg with a standard battery screwer.



Arcadia School

Dubai

Supply from Oasis Enterprises

- Flexdeck stage with railings and access stairs,
- floor covering with carpet
- trapdoor to house the supply lines for the equipment.

Bangor University

Wales

Supply from Centre Stage Uk

- FLEXSTAGE modular platforms with drill height adjustment, integrated into the hall floor.



OIC

Fondazione Opera Immacolata
Concezione
Padova

- Flexdeck stage with railings, disabled ramp, and stair





AV Integrated systems

DECIMA
1948



Integrated Audiovisual System



AV Integrated Systems

- Lighting systems and controls for stage and show
- Architectural lighting systems
- Video and movie projections
- CC TV systems
- Arrangements for radio-tv broadcasts
- Public address systems
- Simultaneous translation
- Electroacoustic projects

Lighting and automation



The architectural luminaires, conceived as a branch of the show equipment, provide a qualitative performance, an energy saving and a longer average life of the lamps.

They satisfy the requirements of light designers, architects and planners of: hotels, congress halls, museums, show rooms, art galleries, shopping centers, thematic parks, cruise ships, etc. where it is necessary to have special light sources.

The available luminaires can be: plano-convex, fresnel, profile, LED, Led Wall, moving lights, of traditional and video type.

Our planning conception consists in the automation systems of:

- Halogen, fluorescent, neon, metal iodides luminaires, darkening curtains, projectors and wind-up screens
- Light integration with audio, video and supervision for "Building Management System"
- Sensors for the control and the mixing of natural light with artificial one
- Touch screen control panels, interface with third systems, controls: DALI, DSI, DMX512, Ethernet, LanWorks, RS232, IN/OUT analogic, volumetric and luxmetric sensors, relay power units and dimmers from 6 to 60A of type SCR, IGBT and sinusoidal, integration with stage lighting control system.



AV Integrated systems



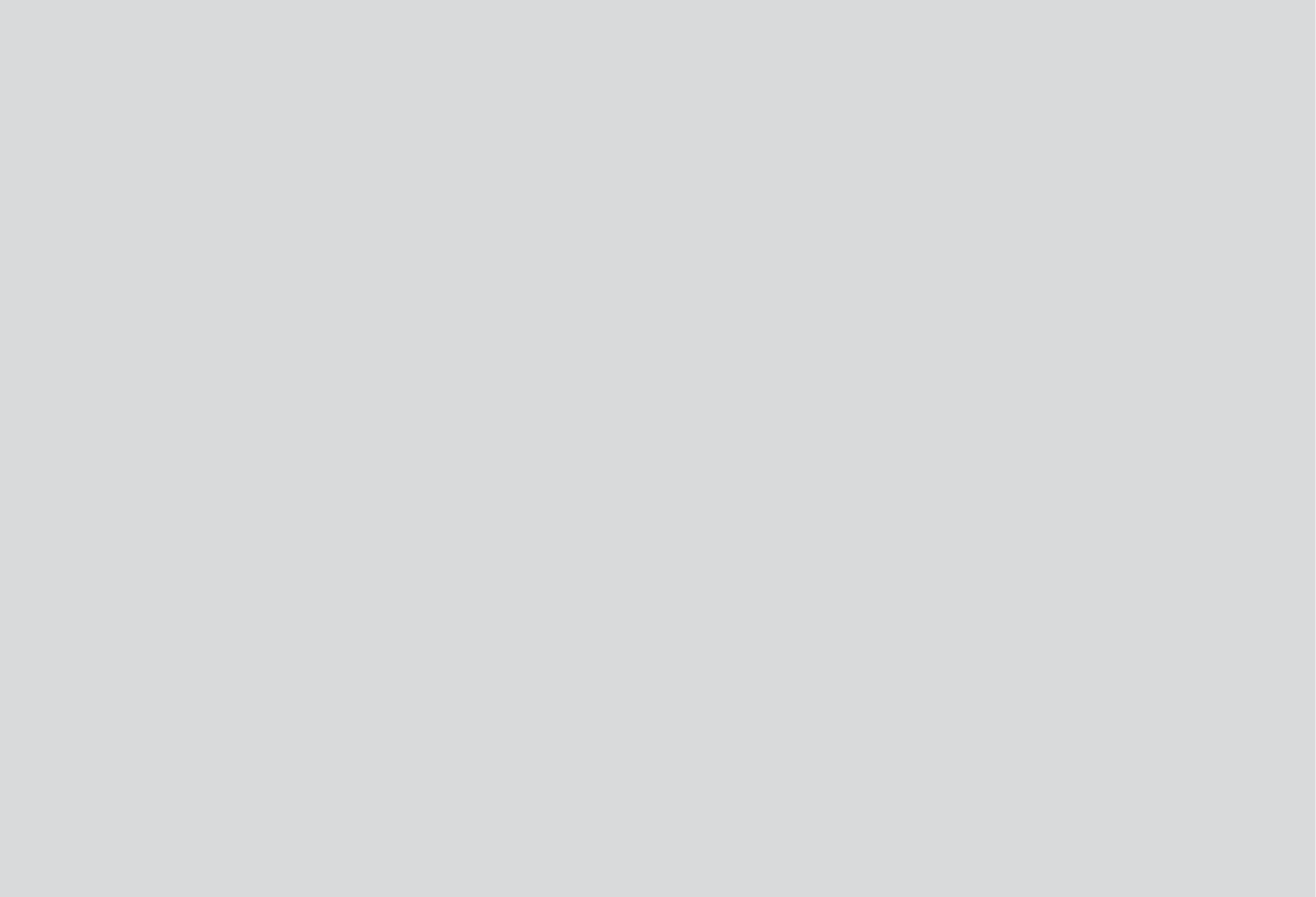

Seats

DECIMA
1948

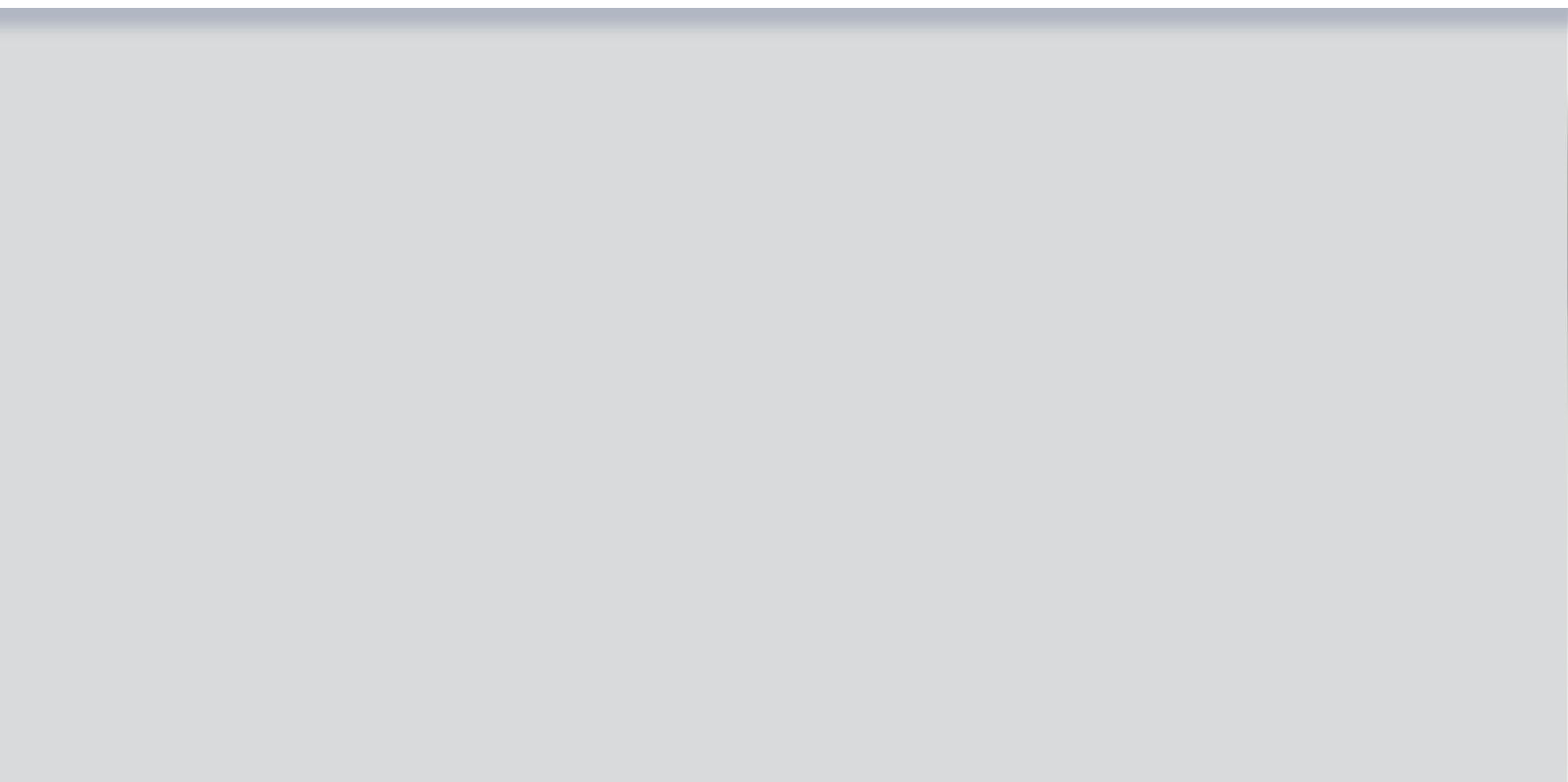

Solution on demand



Decima is always attentive to client satisfaction, even with the most demanding clients, since it designs and engineers exclusive **"Solutions on Demand"** that improve product design and functionality. The Company works with the client to analyse and identify needs and expectations, considering environmental constraints as well as safety regulations, durability and acoustics. **Decima Italia** designers and the Research & Development Department elaborate the design according to the initial parameters identified.

Royale

Comfort and generous proportions combined with a modern design. The perfect solution providing excellent results in terms of both quality and comfort. Roomy and spacious, this finely designed high quality ergonomic chair is both modern and dynamic, combining wood with luxurius materials. There are two models to choose from: full padding with top stitching or elegant upholstery with wooden accents on the armrests, backrest and seat. The special, micro-springs in the seat padding guarantee comfort. An optional foldaway writing tablet that stores neatly into the side, and a modern, multimedia flat-screen system on the chair back are also available.

Design Giovanni Baccolini



Seats

Première

Innovative system of seatings that allows to rationally use the spaces and also ensures excellent levels of comfort. The synchronized movement seat-backrest allows to compact the armchair in extremely reduced spaces, with a resulting large freedom of movement between the rows, to the advantage of the flow of people and the cleaning operations. The armchair folds in a precise and noiseless way thanks to a patented device that cushions and accompanies the movement.

Design Pininfarina



Tempo

Shape and functionality equal comfort. An extremely flexible and original chair, Tempo has been designed with a range of variants and available accessories, in terms of both shape and materials. In addition to the fully-padded and fabric upholstered model, the Tempo model, with wooden backrest, upper armrests and underseat finishes to create a strong visual impact is also available.

Design Giovanni Baccolini



Metropolitan Operà

Operà is an armchair which contributes to create an atmosphere of elegance and comfort thanks to its classic and refined design. No doubt a prestigious solution for the furniture of theatres, auditoriums, conference halls.

Design Giovanni Baccolin



Eidos

The refined essentiality of Eidos is the innovative answer to the traditional request of combining design and functionality and optimizing spaces. The metallic grey color of the structure, coupling with the wide range of fabrics and leathers available, allows the designers to free their imagination in varied chromatic solutions.

Design Giovanni Baccolin

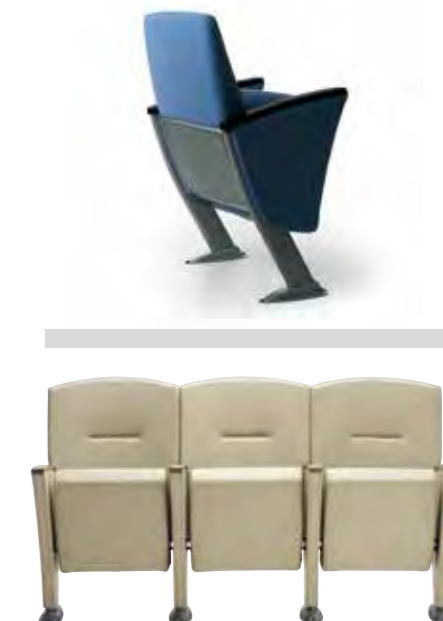

Seats

Papillon

Elegance and functionality, all in one. To facilitate use, Papillon opens and closes easily, like the wings of a butterfly. In the 'open' position, it functions as a comfortable seat, for meetings, conferences or other uses. It is easy to store in the 'closed' position thanks to its reduced size, which facilitates its storage and future use. A versatile chair that stands out, for modern and elegant meeting rooms.

Design Giovanni Baccolini



Concerto

Harmonious balance for best use of space. This compact model has sides that touch the floor, opening upwards thus increasing its dimensions. Its special design creates a large, practical space between the rows. Whether entirely upholstered or with wood accents, this chair is the ideal solution for theatres, auditoriums and conference rooms. The chair can be fitted with a large, foldaway, anti-panic writing tablet that stores neatly into the side or to the back of the seat. The side is also suitable for storing multimedia cables.

Design Giovanni Baccolini



Phoenix

Design inspired by "LouisXVI" style. Internal structure in beech. The armchair is single, with 4 curved legs of solid beech, varnished with different colours on demand. On sight rounded wood profiles, finished with more marked colour. Sides, frame and tip-up seat with wood frame and elastic belts: padded with fire-retardant polyurethane and covered with fire-retardant velvet or fabric.

Certification reaction to fire: IT 1IM

Options: Seat number plates



Paisiello

Chair and stool for historical theatre lodges

Design, inspired by "Louis XV" style and made in solid maple or beech. Stool with seat and chair with seat and back: with elastic belts, padded with fire-retardant polyurethane and covered with fire-retardant velvet or fabric.

Certification reaction to fire: IT 1IM

Options: Seat number plates



Verdi

Chair and sofa for historical theatre lodges

Design, inspired by late '800 style and made in solid maple or beech. Stool with seat and chair with seat and back: with elastic belts, padded with fire-retardant polyurethane and covered with fire-retardant velvet or fabric.

Certification reaction to fire: IT 1IM

Options: Seat number plates



Seats

Salieri

Chair and stool for historical theatre lodges

Design, inspired by "Louis XVI" style and made in solid maple or beech varnished with different colours on demand. Stool with seat and chair with seat and back: with elastic belts, padded with shaped fire-retardant polyurethane and covered with fire-retardant velvet or fabric.

Certification reaction to fire: IT 1IM

Options: Seat number plates



Rossini

Chair and stool for historical theatre lodges

Design, inspired by late '800 style and made in solid maple or beech. Stool with seat and chair with seat and back: with elastic belts, padded with fire-retardant polyurethane and covered with fire-retardant velvet or fabric.

Certification reaction to fire: IT 1IM

Options: Seat number plates



Donizetti

Chair and stool for historical theatre lodges

Design, inspired by late '800 style and made in solid maple or beech.

Stool with seat and chair with seat and back: with elastic belts, padded with fire-retardant polyurethane and covered with fire-retardant velvet or fabric.

Certification reaction to fire: IT 1IM

Options: Seat number plates



Liberty

Structure of curved steel tubular, diam. 25 mms, stove enamelled with RAL colour at choice. Sides, back, tip-up seat and arms: with wood structure, padded with fire-retardant polyurethane and covered with fire-retardant velvet or fabric.

Certification reaction to fire: IT 1IM
Options: Seat number plates

Chair and stool for historical theatre lodges

Historical style of chairs which aesthetically, well matches with our Liberty armchair. Structure of round and curved solid maple or beech, with natural colour or other colours. Padding with fire-retardant polyurethane and covering with fire-retardant velvet or fabric: seat and back of the chair – only seat of the stool.

Certification reaction to fire: IT 1IM
Options: Seat number plates



Musician chairs



M1

C-D1

Ergonomic chairs with structure of steel tubular, stove enamelled with epoxy powders, black color. Seat and back with structure of beech wood, shaped, varnished natural, or padded with shaped fire-retardant polyurethane and covered with fire-retardant velvet or fabric. Back part of back of black integral polyurethane. Back adjustable in height and horizontal depth.
Fire homologation: class 1IM

- M1 Musician seat**
Especially for the strings and the brass
- C-D1 Double bassist chair**
Seat with pneumatic adjustment of height
2 Footrests with adjustable height and rotation
- D-C1 Conductor chair**
Footrest at 46 cms from seat height
- T-K1 Kettle-drummer chair**
With pivoting seat and with pneumatic adjustment of height
Ring 65 cms diam. adjustable in height
Base with 5 feet
- B1 Drummer chair**
Pivoting seat with height adjustment
Base with 5 feet

Seats

Bauhaus

Bauhaus

The essential design is inspired by the "Bauhaus" movement. The modular construction, to facilitate and economize on transportation, assembly and any other eventual maintenance, consists of only three units.

Options: seats and rows numbering

Back + seat + side

The structure, entirely made of steel pipe painted with epoxy powders, (stoving method) consists of frames for backs, tip-up seats and sides with self-supporting base, also suitable for attaching (fixing, fastening) to flat or sloping floors.

Backs and tip-up seats are finished with fire-proof fabric stretched on the respective frames

Italian Fire-retardant Homologation: class 1

Options: Seat and rows numbering



Bauhaus open-air

Same characteristics as the Bauhaus model, but with the back and tip-up seat of micro-perforated steel sheeting (for rain drainage) painted with epoxy powders (stoving method)

In the picture: **Fabiano Maniero**
 (www.fabianomaniero.it)
 Since in 1998 First trumpet of the Teatro la Fenice Orchestra and since 1999 of the "I Solisti Veneti" conducted by Claudio Scimone



D-C1

T-K1

B-1

DECIMA
1948

DECIMA srl
35127 PADOVA - Italy
Via Lisbona, 32
Tel. +39 049 8701655
Fax +39 049 8701656
decima1948.com
info@decima1948.com



DECIMA
ASIA 1948

DECIMA
MIDDLE EAST 1948